

*Engelleri*

*Kaldıran Teknoloji*

*Lifting Technology for*

*Disabled People*



**PUMALIFT**  
Asansör

**ÜRÜN KATALOĞU**

**PRODUCT CATALOGUE**

[www.pumaliftasansor.com](http://www.pumaliftasansor.com)



# engelleri kaldıran teknoloji







## **HAKKIMIZDA**

Dünya standartlarında bir çözüm ortağı olarak en iyi kalitede, en iyi hizmet ve en uygun maliyetle yenilikçi sistemleri oluşturuyor ve Konya SAYGI SANAYİ SİTESİNDE 2.000 m<sup>2</sup> alanda yeni kurduğumuz son model makine parkuru ile KALİTE odaklı üretim yapıyoruz.

Küresel mühendis ve tasarımcı ekibimizle müşterilerimiz için yeni teknolojiler yaratıyoruz. Üniversiteler ve tedarikçilerimizle işbirliği yaparak, Asansör Sektörü için yenilikçi tasarımlar ortaya çıkaran yüksek düzeyde sinerji yaratıyoruz.

## **ABOUT US**

With the experience and confidence we have gained over the years in the elevator sector, we have started our activities to bring a new perspective and dynamism to the sector.

Pumalift Elevator stands by its customers at every stage and after its sales with its qualified human resources, strong infrastructure, visionary perspective and solution-oriented approach. Our company has adopted customer satisfaction as a principle with its production understanding that does not compromise on quality.

**VL 91**

**VILLA TİPİ**  
**HOME LIFT**

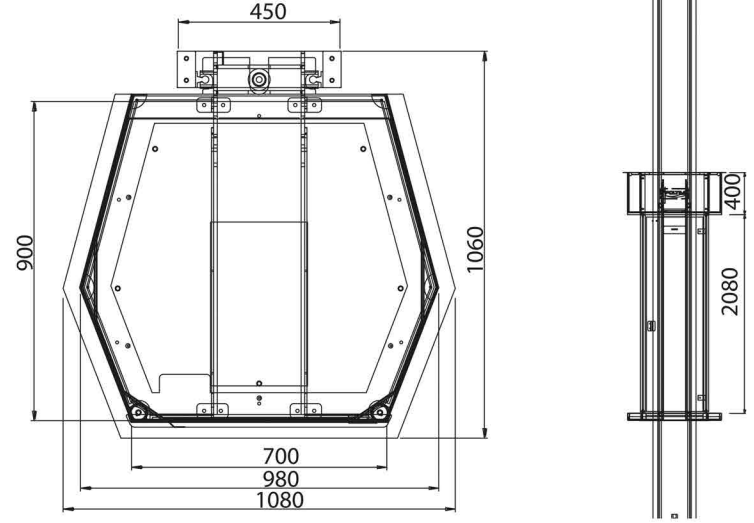

**Türkiye’de ilk ve tek olmanın gururu ile  
iki katlı evinizde poltime dublex asansör ile zarafet  
ve rahatlıkla bir kattan diğerine geçebilirsiniz**

With the pride of being the first and unique in Turkey, you can comfortably move  
from one floor to another with the PumaLift duplex elevator

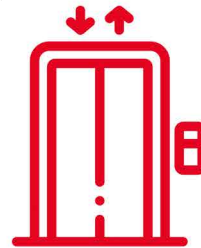



Geleneksel bir asansörün aksine, kompakt bir üründür ve kurulacak yerde önemli yapısal değişiklik gerektirmiyor, bu yüzden evinizde neredeyse her yere monte edilebilir. Yukarı veya aşağı doğru gönderildiğinde özel tasarımı sayesinde boş bir alan bırakır. Evinizin mükemmel görünmesi ve asansörünüzden her gün zevk almanız için tasarlanmış bir modeldir.

Basınca duyarlı emniyet yüzeyleri sayesinde yukarıdan veya aşağıdan temas algıladığı an hareket işlemini durdurur. Kırılmaya dayanıklı camlar kullanılmıştır. Daha fazla güvenlik için, ancak kapı kapandığında asansör hareket edecektir ve asansör hareket halindeyken kapı açılmaz. Elektrik kesildiği zaman asansörümüz UPS sistemi ile otomatik olarak zemin kata inecektir.

Poltime duplex elevator is suitable in your two floor house, you can travel easily and comfortably from ground floor to upper floor or vice versa.

Unlike a traditional elevator, it is a compact product and does not require significant structural changes at the place of installation, Thus it can be installed almost anywhere in your home. When it is sent up or down, it leaves an empty space through our special design. It is a model designed to make your home look perfect and enjoy the comfortable product every day.

By virtue of the pressure sensitive safety surfaces, it stops the movement when it detects contact from above or below. Break resistant glasses are used. For added safety, the lift will move only when the door is closed and the door does not open during the movement. When the power goes out, the lift will automatically go down to the ground floor with the UPS system.

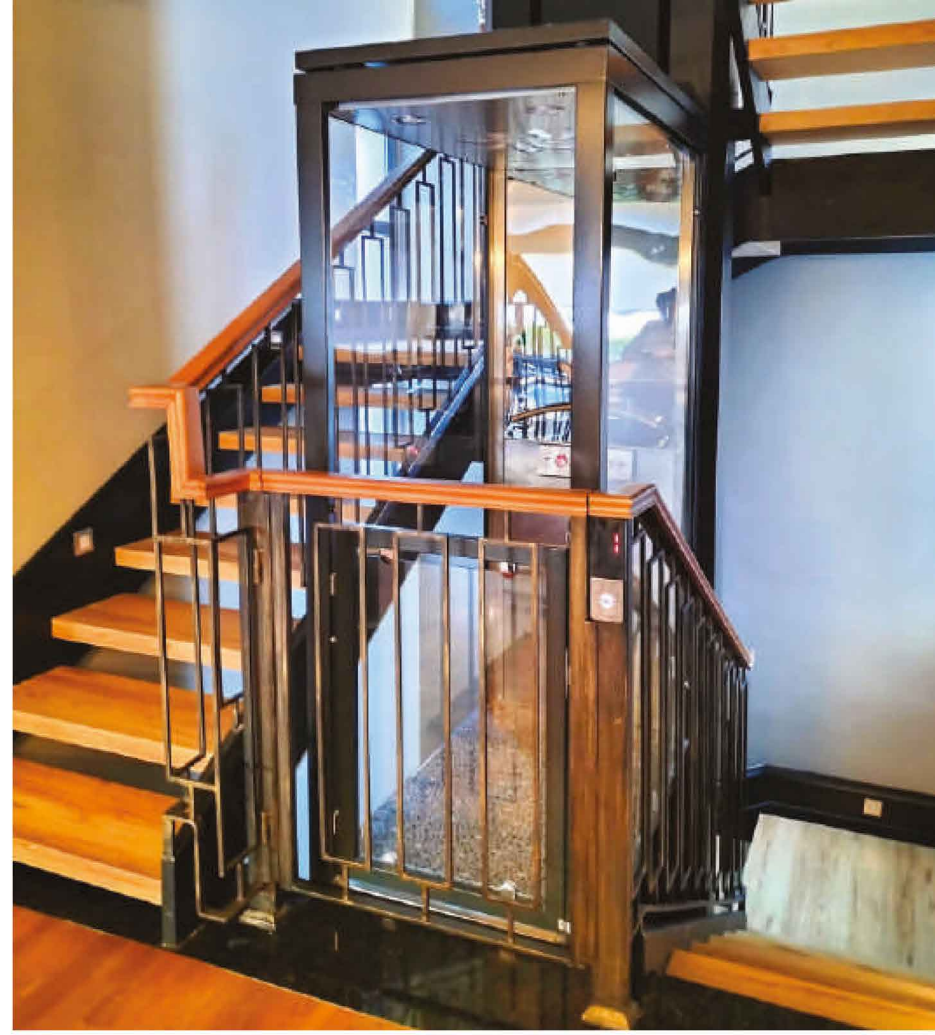

### TEKNİK ÖZELLİKLER | TECHNICAL SPECIFICATIONS

Tahrik Tipi Drive System	Hidrolik / Vidalı Sistem Hydraulic / Screw System
Taşıma Kapasitesi Load Capability	250 kg / 2 Kişi 250 kg / 2 Persons
Max Seyir Mesafesi Distance	9 mt 9 mt
Çalışma Hızı Speed	0,15 mt/sn 0,15 m/sec
Platform İç Ölçüleri Platform Internal Dimensions	750*850 mm / (Özel Ölçü) 750*850 mm / (Special Dimension)
Platform Dış Ölçüleri Platform External Dimensions	1080*1060 mm / (Özel Ölçü) 1080*1060 mm / (Special Dimension)
Kuyu Dibi Pit	Yok None
Kapı Door	Otomatik Kilitli-Güvenlik Siviçli Automatic Locking - Safety Switch
Acil Kurtarma Sistemi Emergency Rescue System	Ups-Manuel Ups / Manual
Anons Sistemi Announcement System	3 Dil / Türkçe-İngilizce-Arapça 3 Languages / Turkish, English, Arabic
İntercom Sistemi Intercom System	Var Available
Ana Güç Gereksinimi Main power requirement	220 V Ac - 50 Hz - Monofaze 220 V Ac - 50 Hz - Monofaze
Montaj Süresi Installation Time	2 Gün 2 Days

# VL 91

## VİLLA TİPİ HOME LIFT

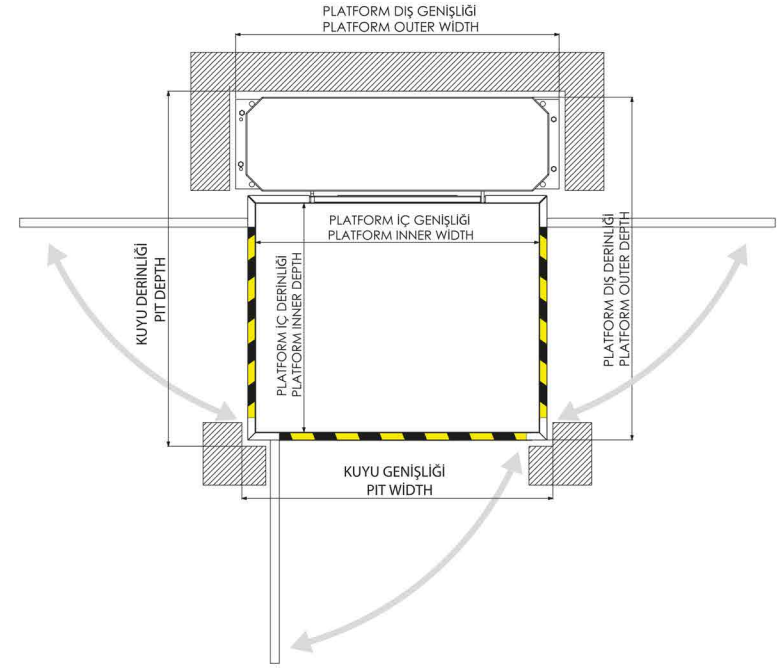
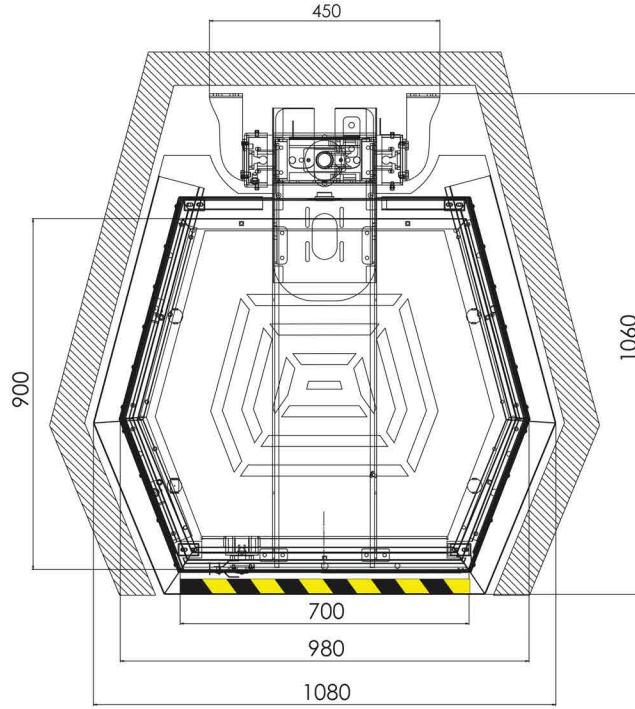

**TOPLAM YÜKSEKLİK**  
TOTAL HEIGHT  
2.300 mm



**KURULUM**  
INSTALLATION  
2-3 Günde Kurulum  
In 2-3 Days



**GÜÇ**  
POWER SUPPLY  
220 - 380 v (AC)



**HIZ**  
TOTAL SPEED  
0,15 m/s



**GARANTİ**  
GUARANTEE  
2 Yıl / Years



**KAT SAYISI**  
FLOOR NUMBER  
4



**MOTOR SİSTEMİ**  
DRIVE SYSTEM  
Hidrolik - Vidalı  
Hydraulic - Screw



**YOLCULUK MESAFESİ**  
TRAVEL HEIGHT  
9 m



## PROFİL RENK SEÇENEKLERİ ELEVATOR STRUCTURE COLOR

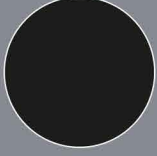

RAL 9005

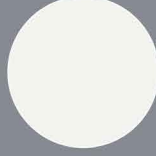

RAL 9016

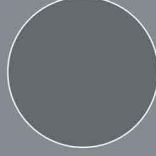

RAL 7012



RAL 7016

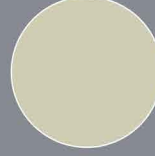

RAL 7032

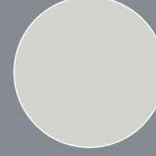

RAL 7035

**GÜVENLİK ÜST  
TABLASI**  
SAFETY TOP TABLE

**GÜVENLİK ÜST  
TABLASI**  
SAFETY TOP TABLE

## CAM RENK SEÇENEKLERİ GLASS COLOR OPTIONS

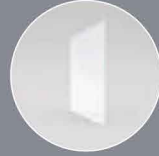

Normal Cam  
Transparent Glass



Mavi  
Blue Glass



Füme  
Fume Glass



Bronz  
Bronze Glass

## PROFİL ÖZELLİKLERİ ELEVATOR STRUCTURE TYPE

- RAL Boyalı / RAL Paint

- Paslanmaz Kaplama/ Stainless Steel

## KAPI ÖZELLİKLERİ DOOR TYPE

- Tam Boy Cam Kapı / Full Height Glass Door

- Yarım Boy Cam Kapı / Half Height Glass Door

**GÜVENLİK ALT TABLASI**  
SAFETY SUB-TRAY

**GÜVENLİK ALT TABLASI**  
SAFETY SUB-TRAY

**KP 901**

**KAPALI TİP PLATFORM**  
**ENCLOSED PLATFORM LIFT**

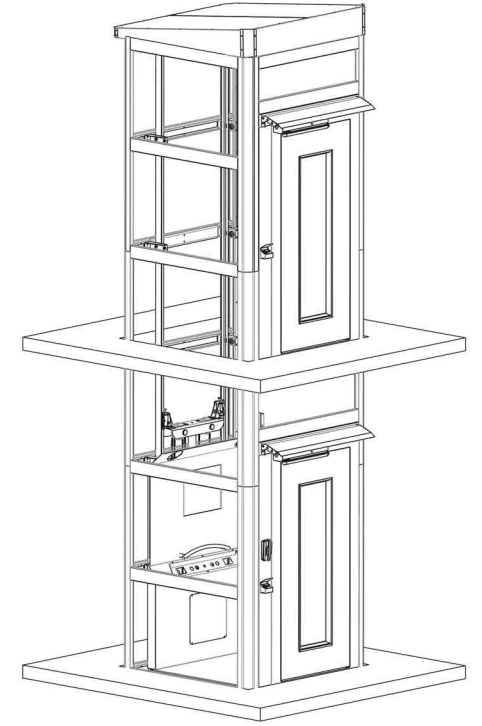
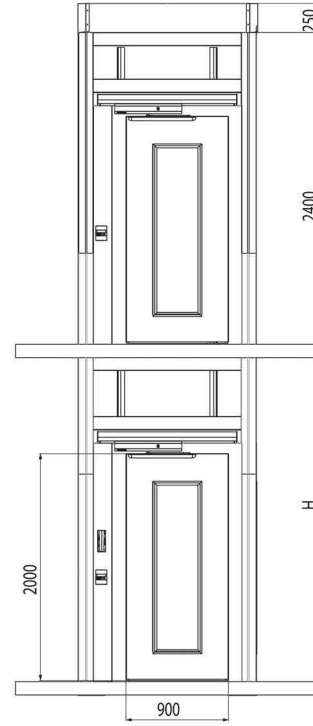

**Kuyu gerektirmemesi sayesinde,  
her alana kolay ve sorunsuz kurulum**

Easy and trouble-free installation in any area as it does not require a pit





Geniş kullanım alanına sahiptir. Tahrik sistemi hidrolik ve sonsuz mil teknolojisi ile mümkündür. İç ve dış mekanlarda güvenle ve emniyetle kullanılabilir. Kuyu gerektirmemesi sayesinde her alana kolay ve sorunsuz kurulum olur. Büyük yapısal değişikliklere gerek duyulmaz. Genellikle 7 durağa kadar olan yerlerde kullanılan bu platformlar katlı yapıları, bireyler için sorun olmaktan çıkartır.

Kullanım alanları, Okul, Camii, Karakol, Rehabilitasyon Merkezleri, Kamu Kurumları, Otel, Sağlık Kuruluşları, Eğitim Merkezleri, Site Alanları ve vb. yerlerde tercih edilir. KP 901 modeli 2006/42/AT yönetmelikleri standartları dahilinde üretilir ve CE işareti ile piyasaya arz edilir. Kullanıcı ve çevre güvenliği en üst düzeyde tutulmuştur.

This model has wide area of usage. The drive system of the lift can be Hydraulic or Screw. It can be used safely and meet your requirements indoor and outdoor. The lift is easy to install and can be placed directly onto the floor, not required pit. It does not need extra construction during the installation. It has 7 stops and helps to customer not to waste time. The outdoor lift is equipped to resist to extreme weather conditions.

Area of usage: Schools, Temples, Police stations, Rehabilitation centers, Public institutions, Private health institutions, Training centers. KP 901 model is produced within the standards of 2006/42 / EC regulations and supplied to the market with CE certificate. User and environment safety are in the highest level.

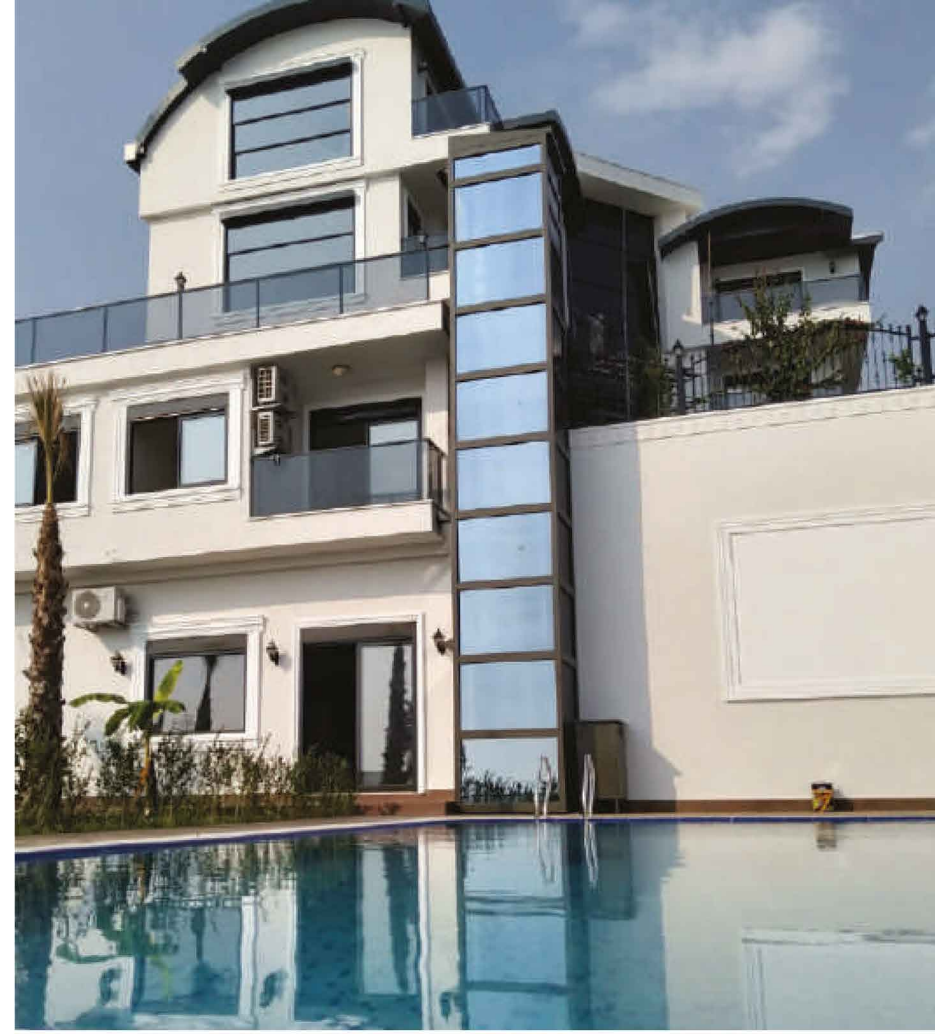

### TEKNİK ÖZELLİKLER | TECHNICAL SPECIFICATIONS

Tahrik Tipi Drive Type	Hidrolik / Vidalı Sistem Hydraulic / Worm Screw
Taşıma Kapasitesi Load Capability	315 / 400 kg 315 / 400 kg
Max Seyir Mesafesi Distance	15 mt 15 mt
Çalışma Hızı Speed	0,15 mt/sn 0,15 mt/sec
Platform İç Ölçüleri Platform Internal Dimensions	1100*1400 mm / (Standart Ölçü) 1100*1400 mm / (Standard Dimension)
Platform Dış Ölçüleri Platform External Dimensions	1600*1600 mm / (Standart Ölçü) 1600*1600 mm / (Standard Dimension)
Kuyu Dibi Pit	120 mm - 150 mm - 250 mm 120 mm - 150 mm - 250 mm
Kapı Door	Tam Otomatik Fully Automatic
Acil Kurtarma Sistemi Emergency Rescue System	Ups / Manuel Ups / Manual
Anons Sistemi Announcement System	3 Dil / Türkçe-İngilizce-Arapça 3 Languages / Turkish, English, Arabic
İntercom Sistemi Intercom System	Var Available
Ana Güç Gerekşinimi Main power requirement	220 V AC - 50 Hz -Monofaze / 380 V AC - 50 Hz -Trifaze 220 V AC - 50 Hz -Monofaze / 380 V AC - 50 Hz -Three Phase

# KP 901

## KAPALI TİP PLATFORM ENCLOSED PLATFORM LIFT

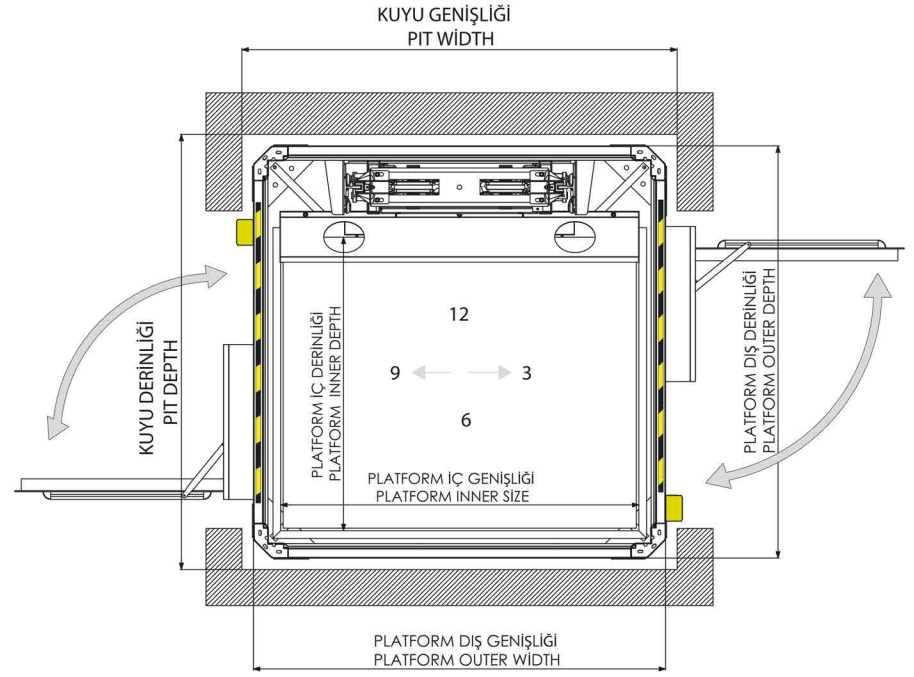
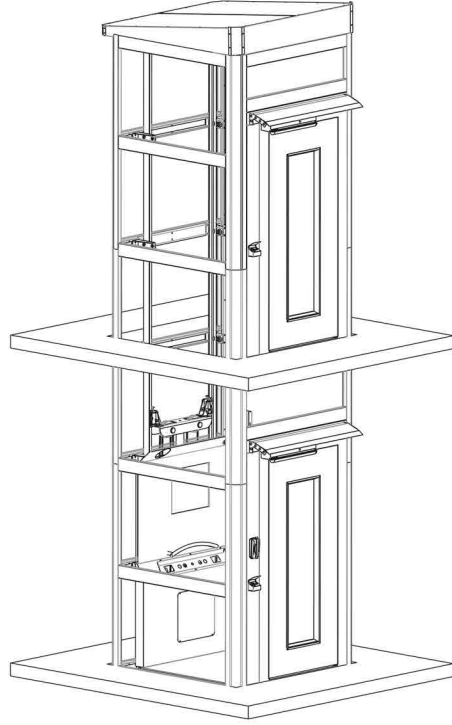
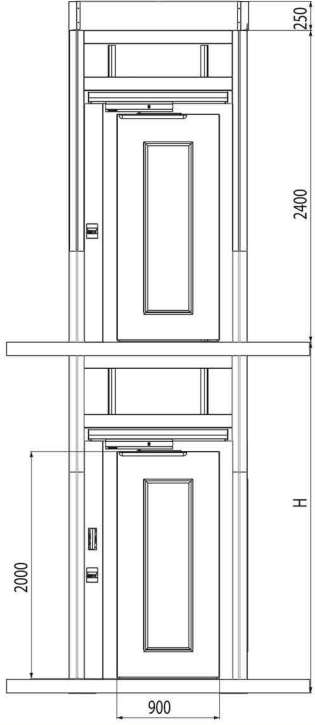

### KABİN YÜKSEKLİĞİ

CABIN HEIGHT  
2.500 mm



### KURULUM

INSTALLATION  
3-4 Günde Kurulum  
In 3-4 Days



### GÜÇ

POWER SUPPLY  
220 - 380 v (AC)



### HIZ

TOTAL SPEED  
0,15 m/s



### GARANTİ

GUARANTEE  
2 Yıl / Years



### KAT SAYISI

FLOOR NUMBER  
7



### MOTOR SİSTEMİ

DRIVE SYSTEM  
Hidrolik - Vidalı  
Hydraulic - Screw



### YOLCULUK MESAFESİ

TRAVEL HEIGHT  
15 m



### KABİN SEÇENEKLERİ

CABIN OPTIONS  
- Platform  
- Asansör Kabini / Elevator Cabin



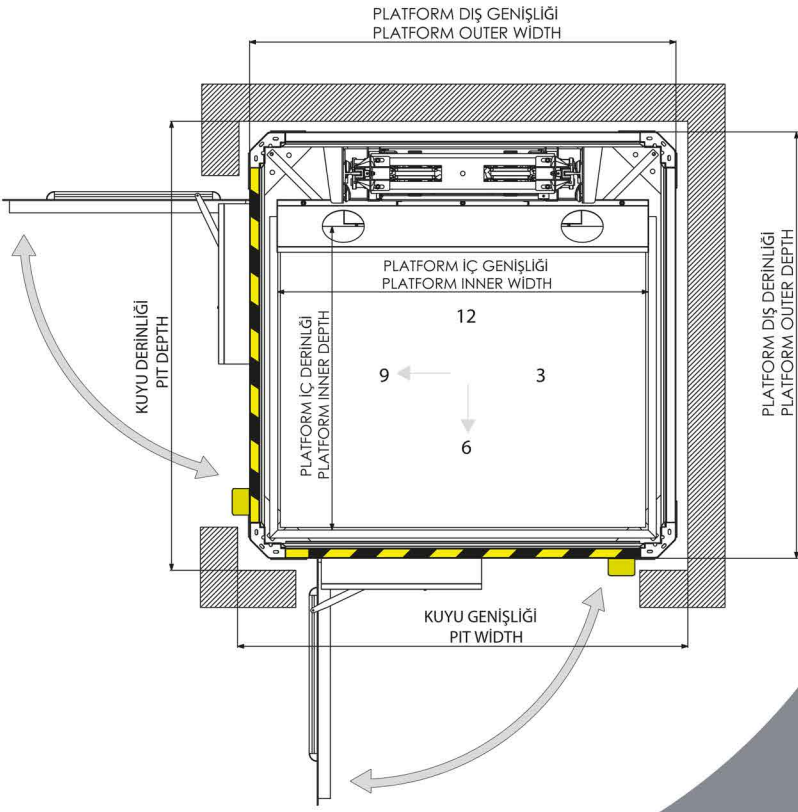

## PROFİL RENK SEÇENEKLERİ ELEVATOR STRUCTURE COLOR

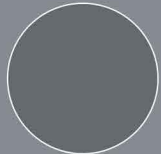

RAL 7012

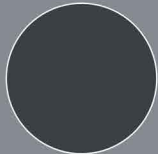

RAL 7016

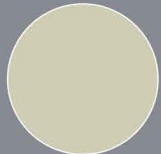

RAL 7032

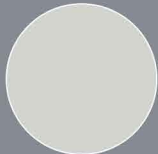

RAL 7035

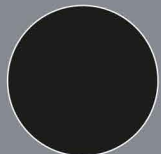

RAL 9005

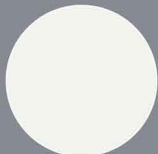

RAL 9016



## CAM RENK SEÇENEKLERİ GLASS COLOR OPTIONS

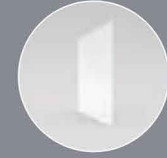

Normal Cam  
Transparent Glass

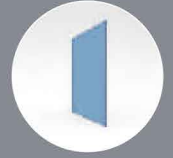

Mavi  
Blue Glass

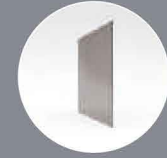

Füme  
Fume Glass

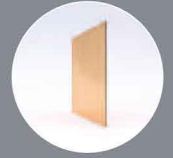

Bronz  
Bronze Glass

## PROFİL ÖZELLİKLERİ ELEVATOR STRUCTURE TYPE

- RAL Boyalı / RAL Paint

## KAPI ÖZELLİKLERİ DOOR TYPE

- Dairesel Otomatik/ Circleslide Automatic  
Door

- Teleskopik Kapı / Telescopic Door

- Manuel Kapı / Manual Door

**KP 901**  
**KABİNLİ - TELESKOPIK**  
**KAPALI PLATFORM**  
CABIN - TELESCOPIC CLOSED PLATFORM

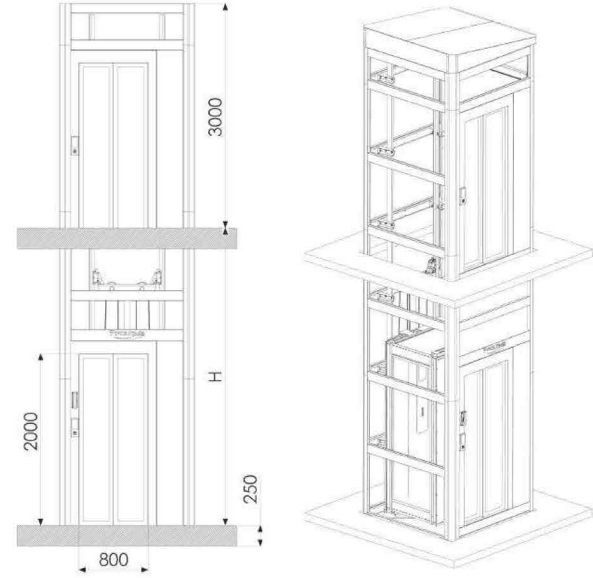

**Kuyu gerektirmemesi sayesinde,  
her alana kolay ve sorunsuz kurulum**

Easy and trouble-free installation in any area as it does not require a pit





Geniş kullanım alanına sahiptir. Tahrik sistemi hidrolik ve sonsuz mil teknolojisi ile mümkündür. İç ve dış mekanlarda güvenle ve emniyetle kullanılabilir. Kuyu gerektirmemesi sayesinde her alana kolay ve sorunsuz kurulum olur. Büyük yapısal değişikliklere gerek duyulmaz. Genellikle 7 durağa kadar olan yerlerde kullanılan bu platformlar katlı yapıları, bireyler için sorun olmaktan çıkartır.

Kullanım alanları, Okul, Camii, Karakol, Rehabilitasyon Merkezleri, Kamu Kurumları, Otel, Sağlık Kuruluşları, Eğitim Merkezleri, Site Alanları ve vb. yerlerde tercih edilir. KP 901 modeli 2006/42/AT yönetmelikleri standartları dahilinde üretilir ve CE işareti ile piyasaya arz edilir. Kullanıcı ve çevre güvenliği en üst düzeyde tutulmuştur.

This model has wide area of usage. The drive system of the Lift can be Hydraulic or Screw. It can be used safely and meet your requirements indoor and outdoor The lift is easy to install and can be placed directly onto the floor, not required pit. It does not need extra construction during the installation. It has 7 stops and helps to customer not to waste time. The outdoor lift is equipped to resist to extreme weather conditions.

Area of usage: Schools, Temples, Police stations, Rehabilitation centers, Public institutions, Private health institutions, Training centers. KP 901 model is produced within the standards of 2006/42 / EC regulations and supplied to the market with CE certificate. User and environment safety are in the highest level.



TEKNİK ÖZELLİKLER   TECHNICAL SPECIFICATIONS	
Ürün Bilgileri Product Information	KP - 901 Kabinli Teknik Özellikleri (TR) KP 901 Cabin type technical specification
Durak Sayısı Number of Stop	Min. 2 Durak (Diagonal) Min. 2 stops (Diagonal)
Seyir Mesafesi Travel Distance	Minimum 500 mm Minimum 500 mm Maksimum İsteğe Bağlı Maximum optional
Hız / Speed	Minimum 0,07 mt/sn Minimum 0,07 mt/sn Maksimum 0,40 mt/sn Maximum 0,40 mt/sn
Taşıma Kapasitesi Carrying capacity	Minimum 250 kg Minimum 250 kg Maksimum 400 kg Maximum 400 kg
Çelik Konstrüksiyon Steel Structure	Laser Kesim Saç Esb Boyalı Laser Cut Steel ESB Painted
Çelik Konstrüksiyon Kaplama Steel Structure Coating	Beyaz Cam / White Glass Füme Cam / Fumed Glass Renkli Cam (Yeşil, Sarı, Mavi) Colored Glass (Green, yellow, Blue) Kompozit (Renkli) Composite (colored)
Kapılar / Doors	Çarpma Kapı (Dairesel Otomatik Kapı) Swing Door (Circular Automatic Door) Teleskopik Kapı (Tam Otomatik) Telescopic Door (Full Automatic) Teleskopik Kapı Camlı (Tam Otomatik) Telescopic Door with Glass (Full Automatic) Gramer Kapı (Otomatik) Folding Door (Automatic)

TEKNİK ÖZELLİKLER   TECHNICAL SPECIFICATIONS	
Kat kapısı ölçüsü Floor door size	Minimum 600x2000mm Minimum 600x2000mm Maksimum 900X2000 mm Maximum 900X2000 mm
Kabin Kapısı Ölçüsü Cabin door size	Minimum 600x2000mm Minimum 600x2000mm Maksimum 900X2000 mm Maximum 900X2000 mm
Platform iç Ölçüsü Platform inner size	Minimum 750x440mm Minimum 750x440mm Maksimum 1100*1300 mm Maximum 1100*1300 mm
Platform dış Ölçüsü Platform outer size	Minimum 1000x1000mm Minimum 1000x1000mm Maksimum 1600*1600 mm Maximum 1600*1600 mm
Platform dış rengi Platform outer color	RAL 7012 - 7016 - 7032 - 7035 9006 - 9016
Kabin / Cabin	Var / Yes
Kabin Kaplaması Cabin coating	304 Satine Paslanmaz 304 Quality Stainless Steel Decostil Kabin / Decostil Cabin Cam Kabin / Glass Cabin Ahşap Kabin / Wooden Cabin
Tahrik Sistemi Drive system	Çift Hızlı Hidrolik Çift Hızlı, Yumuşak Duruş Kalkışlı, Sessiz Ünite Double Speed Hydraulic, Soft Stop Start, Silent Unit
Sesli Anons Sistemi Announce system	Var (Türkçe, Arapça, İngilizce, Rusça) Yes (Turkish, Arabic, English, Russian)
Kuyu Dibi Derinlik Pit depth	Minimum 250 mm Minimum 250 mm

# KP 901

## KABİNLİ KAPALI TİP PLATFORM

ENCLOSED PLATFORM LIFT WITH CABIN

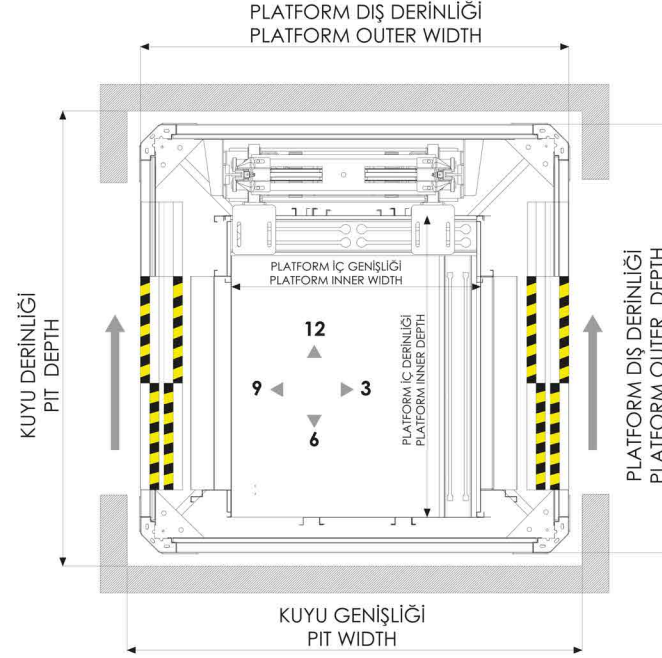
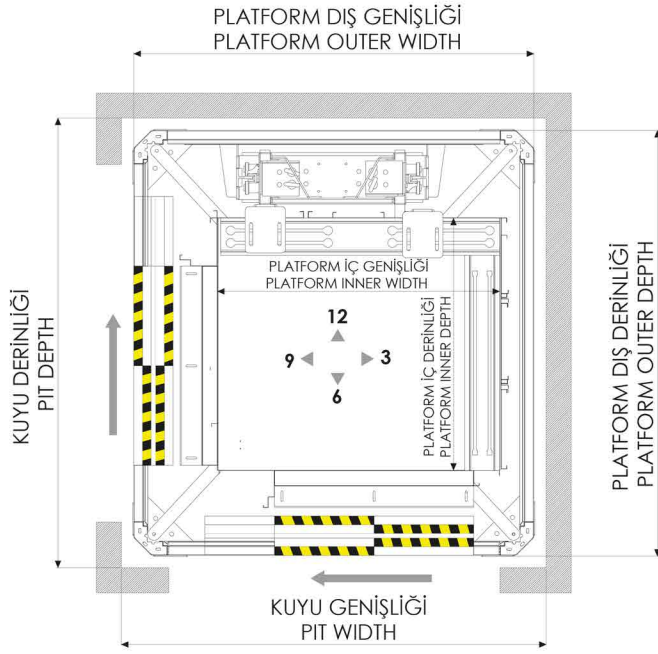

### KABİN YÜKSEKLİĐİ

CABIN HEIGHT  
2.500 mm



### KURULUM

INSTALLATION  
4 Günde Kurulum  
In 4 Days



### GÜÇ

POWER SUPPLY  
220 - 380 v (AC)



### HIZ

TOTAL SPEED  
0,15 m/s-0,40 m/s



### GARANTİ

GUARANTEE  
2 Yıl / Years



### KAT SAYISI

FLOOR NUMBER  
7

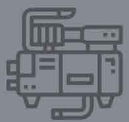

### MOTOR SİSTEMİ

DRIVE SYSTEM  
Hidrolik  
Hydraulic



### YOLCULUK MESAFESİ

TRAVEL HEIGHT  
15 m



### KABİN SEÇENEKLERİ

CABIN OPTIONS  
- Platform  
- Asansör Kabini / Elevator Cabin



**PROFİL  
RENK SEÇENEKLERİ**  
ELEVATOR STRUCTURE  
COLOR

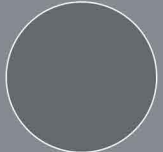

RAL 7012

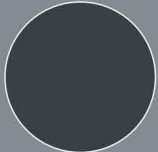

RAL 7016

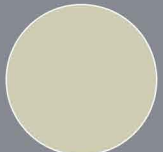

RAL 7032



RAL 7035

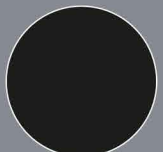

RAL 9005



RAL 9016



**CAM RENK SEÇENEKLERİ**  
GLASS COLOR OPTIONS

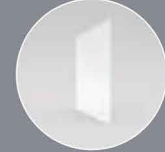

Normal Cam  
Transparent Glass



Mavi  
Blue Glass



Füme  
Fume Glass



Bronz  
Bronze Glass

**PROFİL ÖZELLİKLERİ**  
ELEVATOR STRUCTURE  
TYPE

- RAL Boyalı / RAL Paint

**KAPI ÖZELLİKLERİ**  
DOOR TYPE

- Dairesel Otomatik/ Circleslide Automatic  
Door

- Teleskopik Kapı / Telescopic Door

- Manuel Kapı / Manual Door

**MK 901**

**AÇIK TİP PLATFORM**  
**OPEN PLATFORM LIFT**

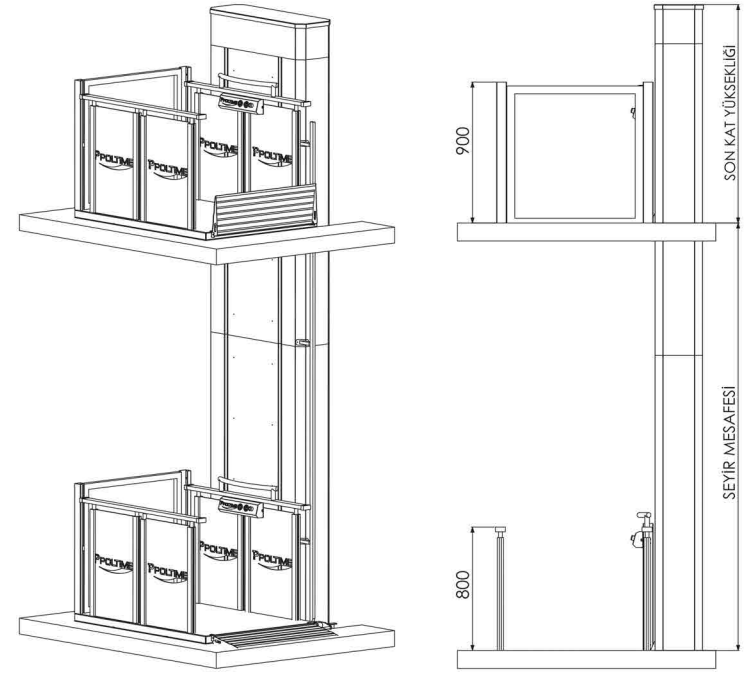

**Kullanıcı ve çevre güvenliği**  
**en üst düzeyde tutulmuştur**

User and environmental  
safety is kept at the highest Level





Çift taraflı taşıyıcı kolonlu, şık ve güvenliğe üst derece önem veren modeldir. İç ve dış mekanda güvenle kullanılır. Dış kaplaması paslanmaz malzemeden oluşmaktadır. Kuyu gerektirmez ve 3 metrelik kod farklarına kadar seyir mesafesi vardır.

Kullanım alanları, Okul, Camii, Karakol, rehabilitasyon merkezleri, kamu kurumları, Otel, Sağlık kuruluşları, Eğitim Merkezleri, Site Alanları ve vb. yerlerde tercih edilir.

MK 105 modeli 2006/42/AT yönetmelikleri standartları dahilinde üretilir ve CE işareti ile piyasaya arz edilir. Kullanıcı ve çevre güvenliği en üst düzeyde tutulmuştur.

This model structured on double pillars. It has high safety standards and stylish. It can be used safely inside and outside. The outer cover is made of steel sheet with a electrostatic coating (stainless steel cover is optional). Does not required pit and can travel up to 3 meter height

Areas of usage; School, Temples, Police station, Rehabilitation center, Public institutions, Hotels, Health facilities, Training centers, Housing estates

MK 901 model is manufactured within the standards of 2006/42 / EC and is presented to the market with CE marking. User and environment safety are in highest level.

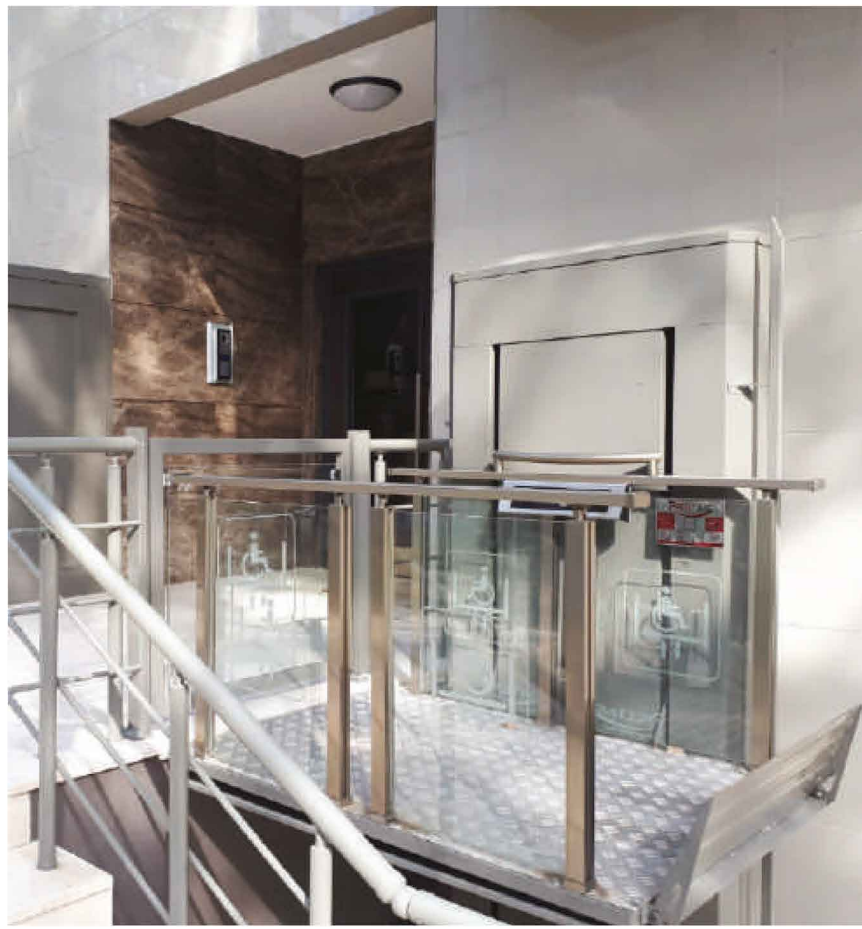

## TEKNİK ÖZELLİKLER | TECHNICAL SPECIFICATIONS

<b>Tahrik Tipi</b> Drive Type	<b>Hidrolik / Vidalı Sistem</b> Hydraulic / Screw
<b>Taşıma Kapasitesi</b> Carrying Capacity	<b>315 kg</b> 315 kg
<b>Max Seyir Mesafesi</b> Maximum Travel Distance	<b>3 mt</b> 3 mt
<b>Çalışma Hızı</b> Working Speed	<b>0,15 mt/sn</b> 0,15 mt/sec
<b>Platform İç Ölçüleri</b> Platform Internal Dimensions	<b>900*1400 mm / (Standart Ölçü)</b> 900*1400 mm / (Standart Dimension)
<b>Platform Dış Ölçüleri</b> Platform External Dimensions	<b>1400*1400 mm / (Standart Ölçü)</b> 1400*1400 mm / (Standard Dimension)
<b>Kuyu Dibi</b> Pit	<b>100 mm</b> 100 mm
<b>Kapı</b> Door	<b>Otomatik Kilitli-Güvenlik Siviçli (Opsiyonel)</b> Automatic Locking-Safety Switch (Optional)
<b>Kumandalar</b> Controls	<b>Katlarda ve Platform Üzerinde Kilitli Kumandalar ve Acil Durdurma Butonu</b> Locked Controls On Floors And Platform Emergency Stop Button
<b>Güvenlik</b> Safety	<b>Tabla Altında Sıkışma Engelleyici Temas Şartelleri Körük (Opsiyonel)</b> Anti Jamming Switches Under The Table / Bellows (Optional)
<b>Ana Güç Gerekşinimi</b> Main power requirement	<b>220 V AC -50 Hz-Monofaze</b> 220 V AC- 50 Hz-Single Phase <b>380 V AC -50 Hz-Monofaze</b> 380 V AC- 50 Hz-Single Phase

# MK 901

## AÇIK TİP PLATFORM OPEN PLATFORM LIFT

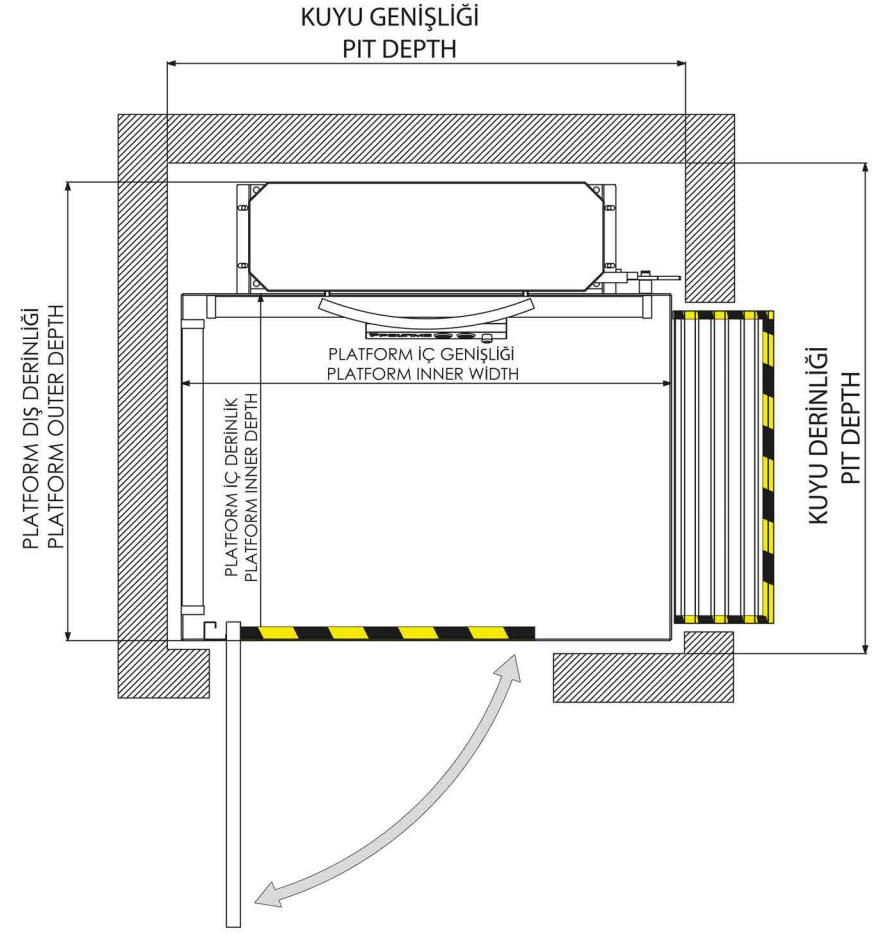
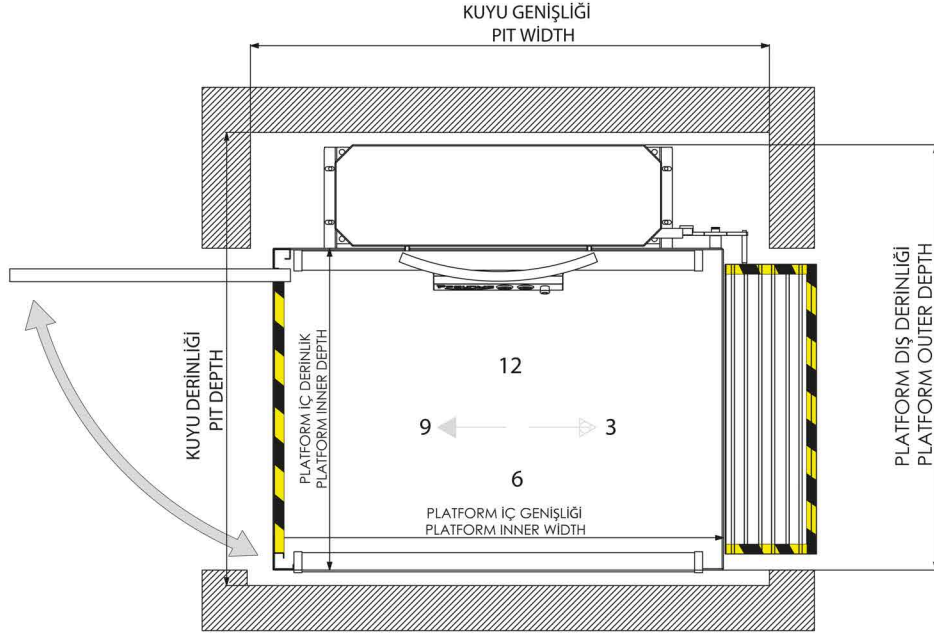

**KABİN YÜKSEKLİĞİ**  
CABIN HEIGHT  
1000 mm



**KURULUM**  
INSTALLATION  
1-2 Günde Kurulum  
In 1-2 Days



**GÜÇ**  
POWER SUPPLY  
220 - 380 v (AC)



**HIZ**  
TOTAL SPEED  
0,15 m/s



**GARANTİ**  
GUARANTEE  
2 Yıl / Years

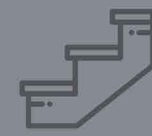

**KAT SAYISI**  
FLOOR NUMBER  
2

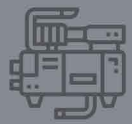

**MOTOR SİSTEMİ**  
DRIVE SYSTEM  
Hidrolik - Vidalı  
Hydraulic - Screw



**YOLCULUK MESAFESİ**  
TRAVEL HEIGHT  
3 m



## CAM RENK SEÇENEKLERİ GLASS COLOR OPTIONS

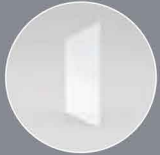

Normal Cam  
Transparent Glass



Mavi  
Blue Glass



Füme  
Fume Glass

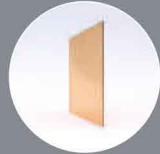

Bronz  
Bronze Glass

## PROFİL RENK SEÇENEKLERİ ELEVATOR STRUCTURE COLOR OPTIONS

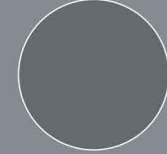

RAL 7012

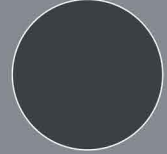

RAL 7016

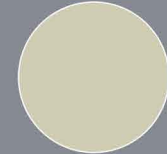

RAL 7032

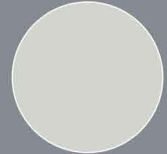

RAL 7035

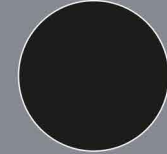

RAL 9005

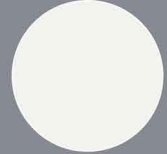

RAL 9016

## PROFİL ÖZELLİKLERİ ELEVATOR STRUCTURE TYPE

- RAL Boyalı / RAL Paint

- Paslanmaz Kaplama / Stainless Steel

## KAPI ÖZELLİKLERİ DOOR TYPE

- Dairesel Otomatik Kapı / Circleslide  
Automatic Door

- Manuel Kapı / Manual Door



**POLT 901**

**YATAY TİP PLATFORM**

**HANDICAPPED STAIR STRAIGHT  
TYPE PLATFORM LIFT**

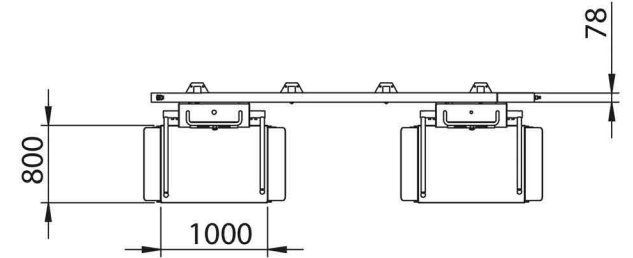
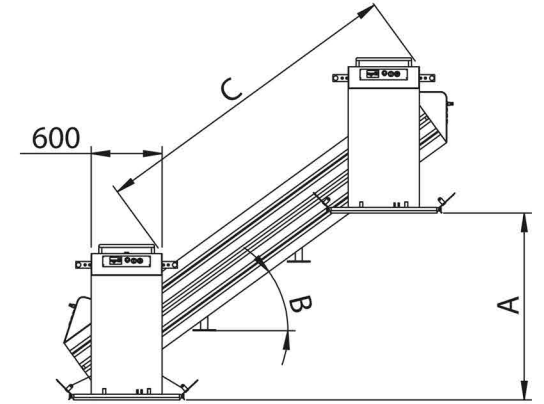

**Kullanılmadığı zamanlar  
otomatik olarak katlanır ve yer işgal etmez**

Automatically folds when not in use and does not occupy space

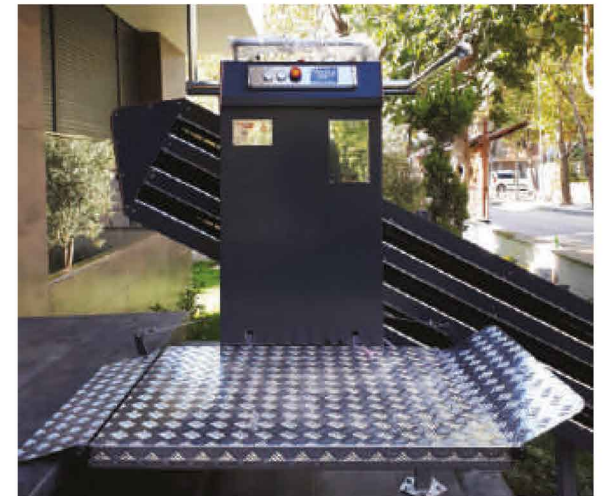



İç ve dış mekan merdivenlere monte edilir. Yürüme engelli veya tekerlekli sandalye kullanıcılarının refakatçiyi ihtiyaç duymadan güvenli bir şekilde ulaşımını sağlar. Merdiven kenarında duvara veya basamaklara özel ayakları ile monte edilen özel raylar üzerinde hareket eder. Dış ortam şartlarına uygun, dış kaplaması paslanmaz malzemeden imal edilmektedir. Kullanılmadığı zamanlar otomatik olarak katlanır ve yer işgal etmez.

Kullanım alanları, Okul, Camii, Karakol, rehabilitasyon merkezleri, kamu kurumları, Otel, Sağlık kuruluşları, Eğitim Merkezleri, Site Alanları ve vb. yerlerde tercih edilir.

POLT 901 modeli 2006/42/AT yönetmelikleri standartları dahilinde üretilir ve CE işareti ile piyasaya arz edilir. Kullanıcı ve çevre güvenliği en üst düzeyde tutulmuştur.

This model is suitable on indoor and outdoor stairs. It provides safe access for disabled or wheelchair users without the need for a companion. It moves on special rails mounted on the wall or steps with special feet on the stair edge. Exterior coating is made of steel sheet with a electrostatic coating ( stainless steel cover is optional). When not in use, it folds automatically and does not occupy space.

Area of usage; School, Temples, Police station, Rehabilitation center, Public institutions, Hotels, Health facilities, Training centers, Housing estates.

POLT 901 model is manufactured within the standards of 2006/42 / AT and presented to the market with CE marking. User and environment safety are in the highest level.



## TEKNİK ÖZELLİKLER | TECHNICAL SPECIFICATIONS

Uygulama Application	Düz Merdivenler / İç-Dış Mekan Straight Stairs / Indoor-Outdoor
Tahrik Tipi Drive Type	Dışlı Sistemi Gear System
Taşıma Kapasitesi Carrying Capacity	225 kg 225 kg
Çalışma Hızı Working Speed	0,07/0,15 mt/sn 0,07 / 0,15 mt/sec
Ray Sistemi Rail System	Lineer Kızak Sistemi Linear Guideway System
Çıkabilecek Eğim Escalation Angle	45 Derece 45 Degrees
Tabla Kapatma-Açma Table Closing-Opening	Tam Otomatik Fully Automatic
Güvenlik Kol Mekanizması Safety Arm Mechanism	Tam Otomatik Fully Automatic
Tabla Rampası Table Ramp	Tam Otomatik Fully Automatic
Kumandalar Controls	Duraklarda Anahtarlı Çağır, Tabla Kapat-Aç ve Platform Üstünde Aşağı-Yukarı Butonu ve Acil Durdurma Butonu Call by switch at stops, button for movement on platform and ground. Emergency stop button
Güvenlik Sistemi Safety System	Tabla Altında Sıkışma Engelleyici Temas Şarteli Anti jamming switch system under the table
Ana Güç Gerekşinimi Main power requirement	220 V AC - 50 Hz - Monofaze 220 V AC - 50 Hz - Single Phase
Platform İç Ölçüleri Platform Internal Dimensions	800*1050 mm / (Standart Ölçü) 800*1050 mm / (Standard Dimension)

# POLT 901

## YATAY TIP PLATFORM

HANDICAPPED STAIR STRAIGHT  
TYPE PLATFORM LIFT

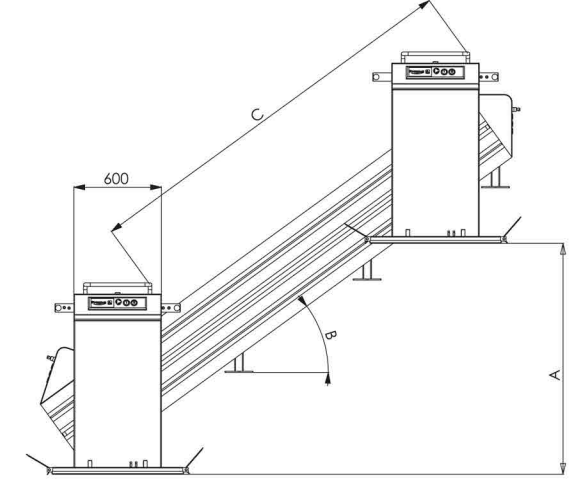
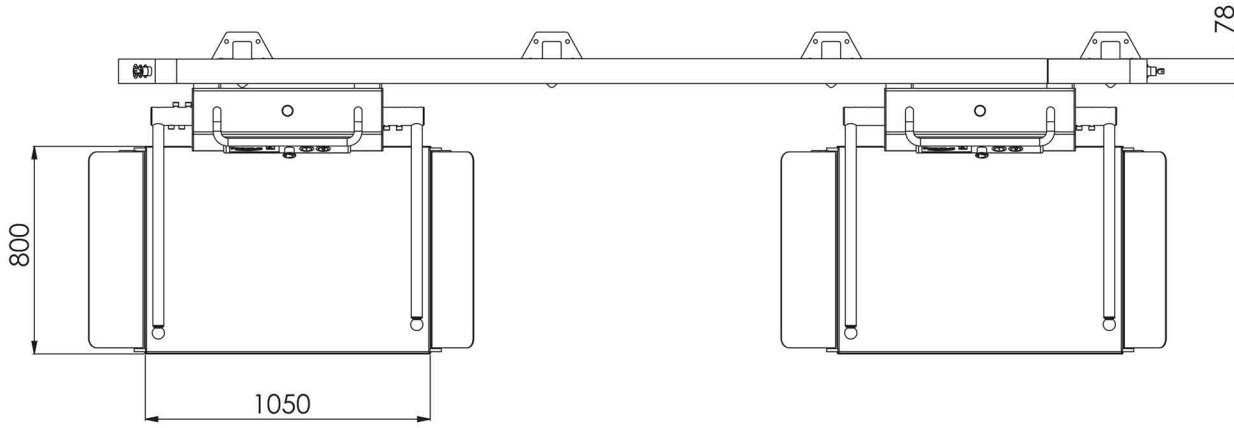

### YOLCULUK MESAFESİ

TRAVEL HEIGHT  
17 m



### KURULUM

INSTALLATION  
1 Günde Kurulum  
In 1 Days



### GÜÇ

POWER SUPPLY  
220 v



### HIZ

TOTAL SPEED  
0,15 m/s



### GARANTİ

GUARANTEE  
2 Yıl / Years

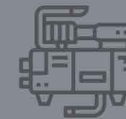

### MOTOR SİSTEMİ

DRIVE SYSTEM  
Vidalı  
Screw



## PROFİL ÖZELLİKLERİ

### ELEVATOR STRUCTURE TYPE

- RAL Boyalı / RAL Paint

- Paslanmaz Kaplama / Stainles Steel

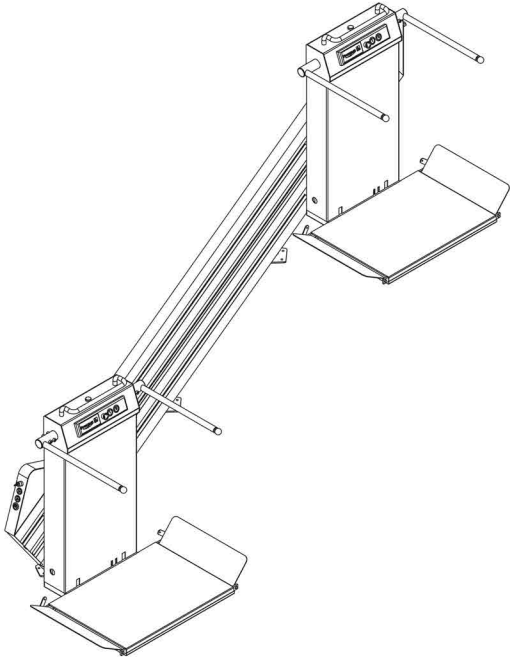

## PROFİL RENK SEÇENEKLERİ

### ELEVATOR STRUCTURE COLOR OPTIONS

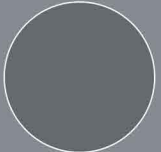

RAL 7012

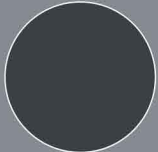

RAL 7016

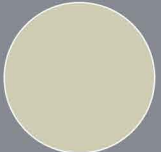

RAL 7032



RAL 7035



RAL 9005

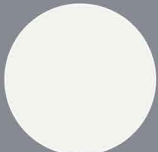

RAL 9016



**MKS 58**

**MAKASLI TIP PLATFORM  
SCISSORS PLATFORM LIFT**

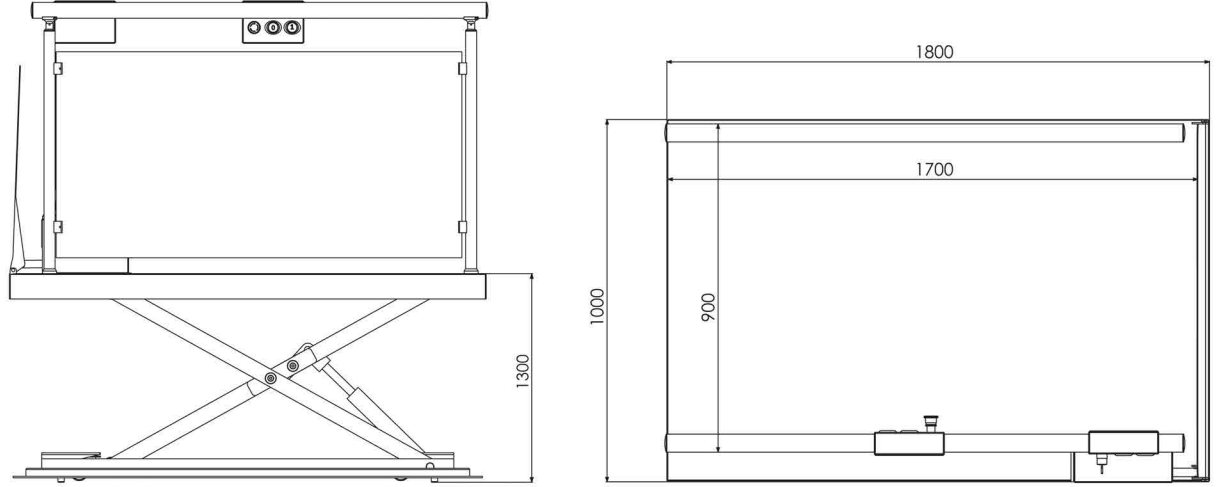

**Türkiye'nin öncü makaslı tip platformu, Otomatik motorlu kapanıp açılan rampası ile engelli arabasının girişini kolaylaştırır ve hareket ederken kapanıp güvenlik duvarı oluşturur**

Turkey's leading scissor type platform lift with its automatic motorized closing and opening ramp, it facilitates the entrance of the disabled wheelchair and creates a firewall when it moves.





Türkiye’de ilklerden olan bu platform 9cm kapalı mesafesi ile rakip ürünlerin önüne geçmektedir. Uygulandığı yerde küçük ve zarif yapısı ile neredeyse inşaat işi gerektirmez. İç ve dış mekanda kullanıma uygundur. Dış yapısı ESB boyalı ve paslanmaz seçenekleri vardır. Otomatik motorlu kapanıp açılan rampası ile engelli arabasının girişini kolaylaştırır ve hareket ederken kapanıp güvenlik duvarı oluşturur.

Kullanım alanları, Okul, Camii, Karakol, rehabilitasyon merkezleri, kamu kurumları, Otel, Sağlık kuruluşları, Eğitim Merkezleri, Site Alanları ve vb. yerlerde tercih edilir.

MKS 58 modeli 2006/42/AT yönetmelikleri standartları dahilinde üretilir ve CE işareti ile tüketiciye sunulmuştur. Kullanıcı ve çevre güvenliği en üst düzeyde tutulmuştur.

This is a new designed product in Turkey and ahead of its competitors with 9 cm close distance feature. It does not require construction work with its small and elegant structure. It is suitable for indoor and outdoor use. External structure ESB painted and stainless steel options are available. The automatic motorized ramp facility makes easier the entry of the wheelchair. During the movement automatically close it and creates a safety wall.

Area of usage; School, Temples, Police station, Rehabilitation center, Public institutions, Hotels, Health facilities, Training centers, Housing estates.

MKS 58 models is produced within the standards of 2006/42 / EC and presented to the consumer with CE certificate. User and environment safety are in the highest level.



## TEKNİK ÖZELLİKLER | TECHNICAL SPECIFICATIONS

Tahrik Tipi Drive Type	Hidrolik Hydraulic
Taşıma Kapasitesi Carrying Capacity	315 kg 315 kg
Max Seyir Mesafesi Maximum Travel Distance	1300 mm 1300 mm
Çalışma Hızı Working Speed	0,1 mt/sn 0,1 mt/sec
Platform İç Ölçüleri Platform Internal Dimensions	900*1400 mm / (Standart Ölçü) 900*1800 mm / (Standart Ölçü) 900*1400 mm / (Standard Dimension) 900*1800 mm / (Standard Dimension)
Platform Dış Ölçüleri Platform External Dimensions	900*1400 mm / (Standart Ölçü) 900*1800 mm / (Standart Ölçü) 900*1400 mm / (Standard Dimension) 900*1800 mm / (Standard Dimension)
Kuyu Dibi Pit	100 mm 100 mm
Kapı Door	Otomatik Kilitli-Güvenlik Siviçli (Opsiyonel) Automatic Locking-Safety Switch (Optional)
Kumandalar Controls	Katlarda Kilitli Kumandalar ve Acil Durdurma Butonu, Platform Üzerinde Uzayabilen Kilitli Kumanda Locked on floors, Emergency stop button, Extensible locked command on the platform
Platform Rampası Platform Ramp	Tam Otomatik Fully Automatic
Güvenlik Körüğü Safety Bellows	Var Available
Ana Güç Gerekşinimi Main power requirement	220 V Ac-50 Hz / 380 V Ac-50 Hz 220 V Ac-50 Hz / 380 V Ac-50 Hz

# MKS 58

## MAKASLI TIP PLATFORM SCISSORS PLATFORM LIFT

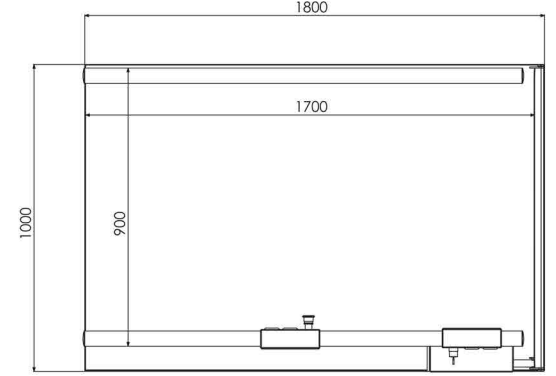
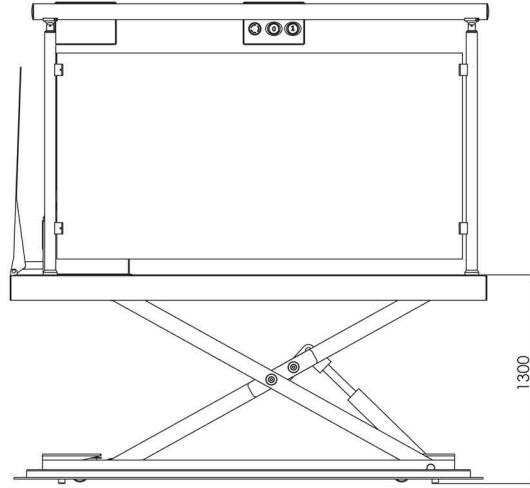
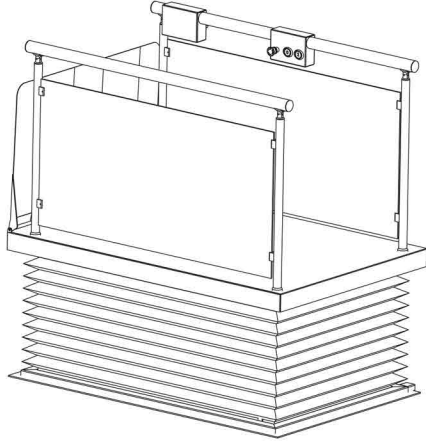

**KAPALI YÜKSEKLİK**  
CLOSED HEIGHT  
100 mm



**KURULUM**  
INSTALLATION  
1 Günde Kurulum  
In 1 Days



**GÜÇ**  
POWER SUPPLY  
220 V  
380 V



**HIZ**  
TOTAL SPEED  
0,15 m/s



**GARANTİ**  
GUARANTEE  
2 Yıl / Years



**KAT SAYISI**  
FLOOR NUMBER  
2



**MOTOR SİSTEMİ**  
DRIVE SYSTEM  
Hidrolik  
Hydraulic



**YOLCULUK MESAFESİ**  
TRAVEL HEIGHT  
1300 mm



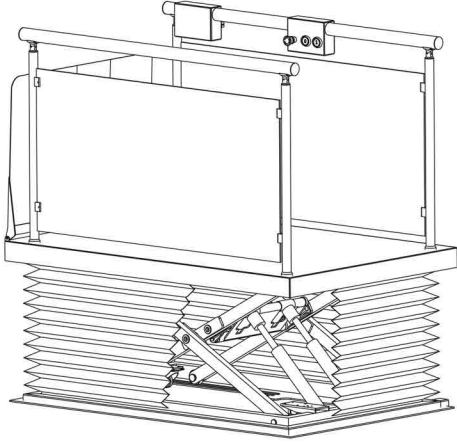

## CAM RENK SEÇENEKLERİ

### GLASS COLOR OPTIONS

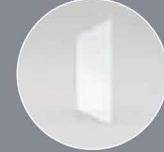

Normal Cam  
Transparent Glass



Mavi  
Blue Glass



Füme  
Fume Glass



Bronz  
Bronze Glass

## KAPI ÖZELLİKLERİ

### DOOR TYPE

- Dairesel Otomatik Kapı / Circleslide Automatic Door
- Manuel Kapı / Manual Door

## PROFİL RENK SEÇENEKLERİ

### ELEVATOR STRUCTURE COLOR OPTIONS

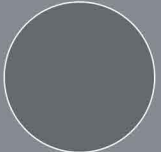

RAL 7012

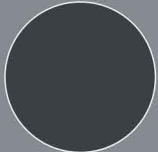

RAL 7016

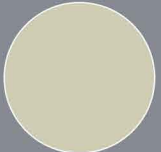

RAL 7032



RAL 7035

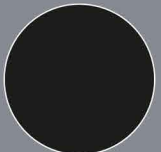

RAL 9005

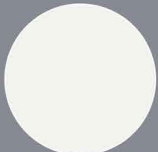

RAL 9016

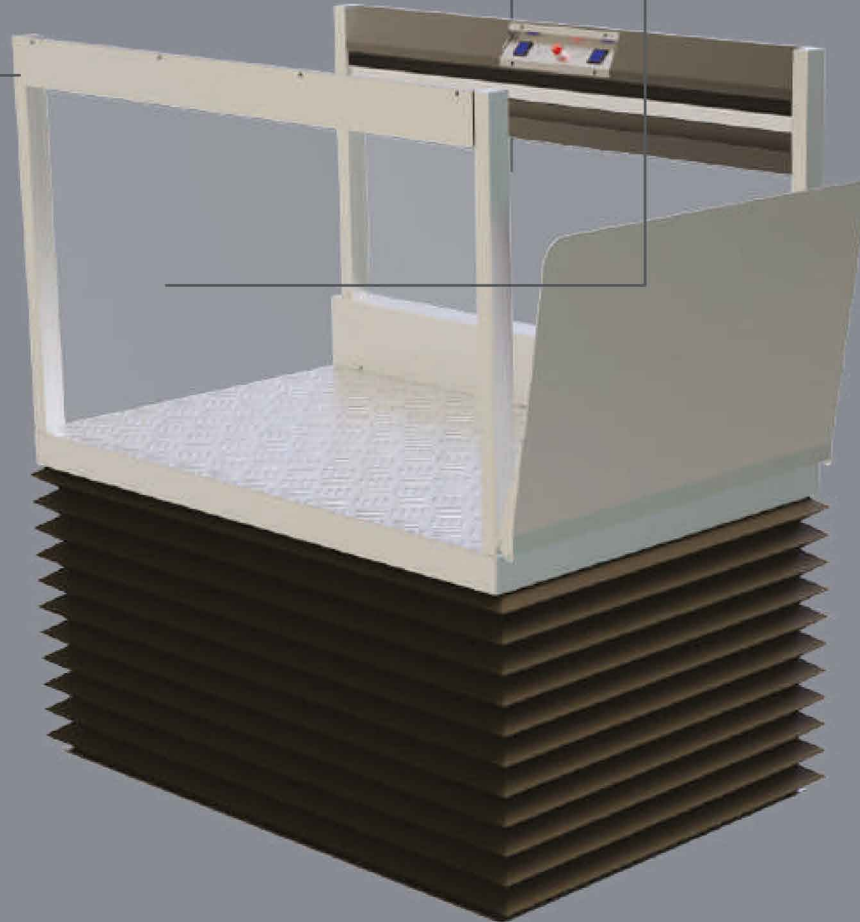

**POLT 902**  
**YATAY TİP DÖNÜŞLÜ**  
**PLATFORM**  
HANDICAPPED STAIR CURVED TYPE  
PLATFORM LIFT



Kavisli ve döner merdivenler için geliştirilmiş üstün teknoloji, tekerlekli sandalyenizden inmenize ve binmenize yardım almanıza gerek olmadan kullanabileceğiniz platform tipi merdiven asansör modelidir. İç ve dış mekan uygulamaları için uygundur. Platformu kurulduktan sonra, yanda kapalı durduğu andan itibaren merdivenler tamamen kullanılabilir. İnşaat masrafı gerektirmez, 300 kg yükleme kapasitesine sahiptir. Yatay tip platform asansörü, birinci sınıf tasarımı ile aile ortamına fonksiyonellik ve zarafet katar. Yumuşak renkler, yuvarlak şekiller, katlanabilir güvenlik barları, minimum engel, platform tipi merdiven asansörleri beklentilerinizi karşılar.

**Kavisli ve döner merdivenlere özgü tasarım, güçlü ve modern yapısı ile fonksiyonellik ve zarafet katar.**

The design specific for curved and revolving stairs that adds functionality and elegance with its strong and modern structure





Advanced technology developed for curved and spiral staircases; It is a stairlift model that helps you get in and out of your wheelchair without getting help from anyone . It is suitable for indoor and outdoor use. It does not require any expense. It has a loading capacity of 300 kg. It is a curved type platform lift with its first class design, which is suitable for family environment. It adds functionality and elegance. With its soft colors, round shapes, foldable safety bars, it meets your expectations.

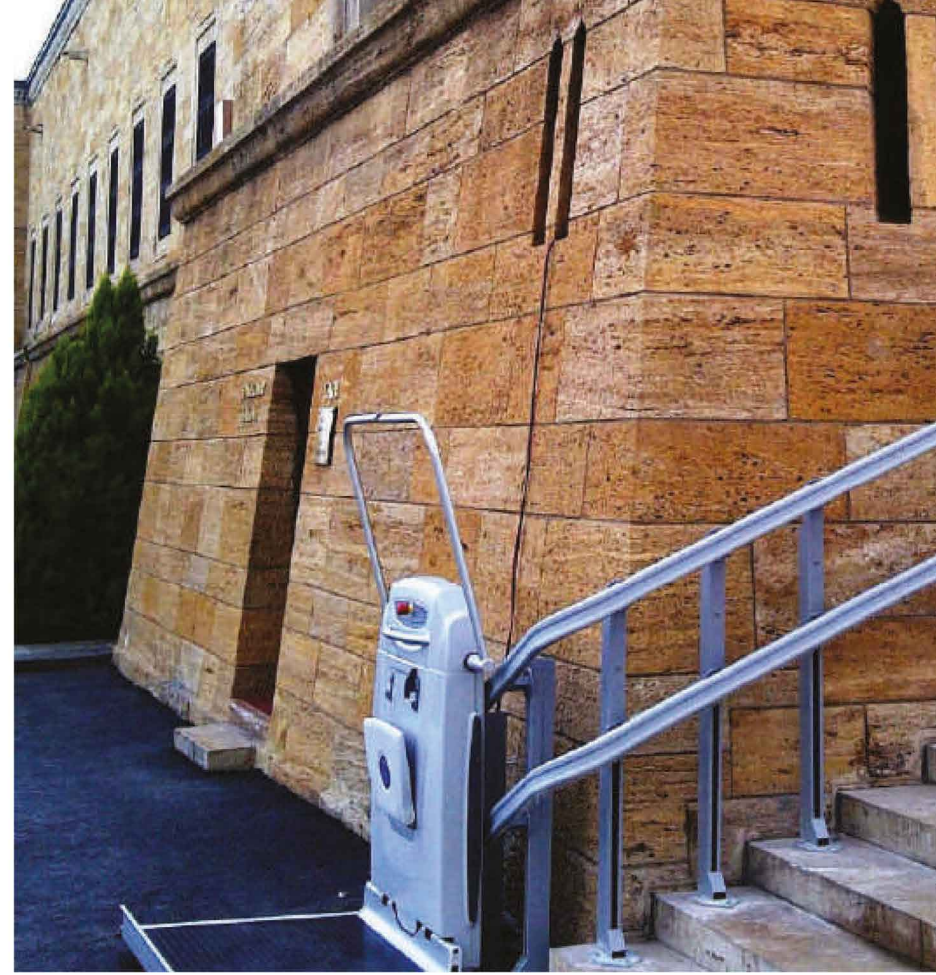
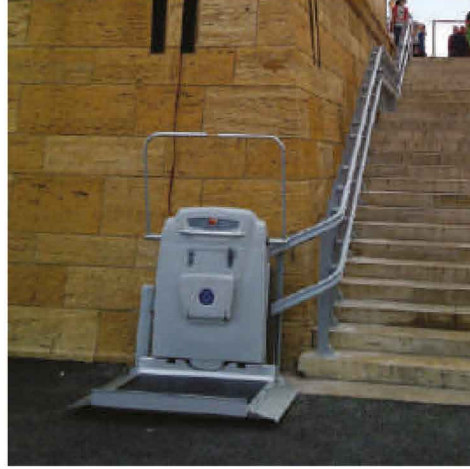

### TEKNİK ÖZELLİKLER | TECHNICAL SPECIFICATIONS

Uygulama Application	Değişken eğimli yol ve dönüşlü merdivenlerde,iç ve dış ortamlara uygulanabilir. It can be applied indoors and outdoors with variable slope or curved staircase.
Taşıma Kapasite Carrying Capacity	300 Kg 300 Kg
Hız Speed	0,07 m/s (standart) ve yumuşak kalkış duruş ile 0,13 m/s (Opsiyonel) 0,07 m/s standard speed 0,13 m/s faster speed and smooth drive (optional)
Merdiven Geniřlięi Stair Width	1500 mm 1500 mm
Alt Kademe Lower Landing	1700 mm 1700 mm
Eriřim Access	180° 180°
Ray Rail	RAL 9006 epoksi boyalı çift alüminyum profilden oluşur. Consists of RAL 9006 epoxy painted double aluminum profile
Ray Baęlantı Rail Connection	Zemine metal ayaklar veya duvara baęlantı konsolları ile. With metal feet to the floor or connection consoles to the wall
Ölçüler (mm) (L x P) Dimensions (mm) (LxP)	650 x 860 'dan başlayan ölçülerle With dimensions starting from 650 x 860
Platform Platform Structure	Galvanizli çelik ve alüminyum ile PVC kaplı Galvanized steel and aluminum with PVC coated
Platform Rengi Platform Colour	RAL 7047 RAL 7047

### TEKNİK ÖZELLİKLER | TECHNICAL SPECIFICATIONS

Türü Type	Otomatik açılır ve kapanır platform, koruma kolları ve erişim rampaları bulunmaktadır. Automatic opening and closing platform, with protection arms and access ramps
Kat Kumandaları Floor Controls	Ergonomik tuş ile sürekli basarak yukarı / aşağı komuta Up / Down command by pressing continuously with ergonomic key
Platform Kumandaları Platform Controls	Ergonomik sabit basılı komut tuşu; acil stop butonu; kilitleme. Ergonomic hard-pressed command key; Emergency stop button; Locking
Güç Kaynaęı Power	230V, tek fazlı, 50Hz, 16A 230V, single phase, 50HZ , 16A
Voltaj kontrolü Voltage	24V 24V
Maximum Güç Max.Power	0,75kW 0,75kW
Tahrik Drive System	Üstten monteli sistemi Top mounted system
Güvenlik Safety	Hız sınırlayıcı, sabit basınç komutları, platform üzerinde anti ezilme ve anti darbe,anti sıkıştırma emniyet düzeneęi, çift elektrik devre koruması; acil alçaltma sistemi Speed limiter, constant pressure commands, anti-crush and anti-impact on platform, anti-jamming safety arrangement, double electrical circuit protection; emergency stop button; locking
Standart Standard	Makine Direktifi 2006/42/EC; EN 81-40:2009 Machine router 2006/42/EC , EN81-40:2009
Opsiyonel Optional	Uzaktan kumanda, anti elektrik kesintisi sistemi, katlanır koltuk Remote control, anti-power system, folding seat



**KT 62**  
**KOLTUK TİP PLATFORM**  
**STAIR CHAIR LIFT**

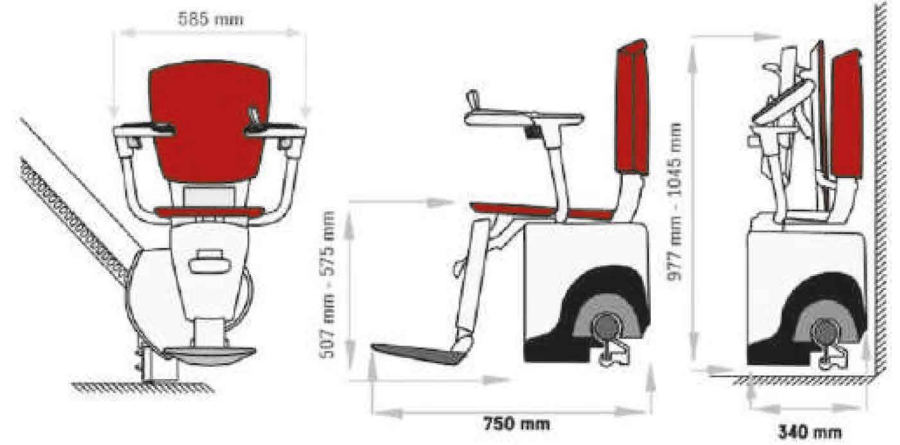

**Güçlü ve basit dizaynı sayesinde, erişilebilirliğin gerekliliklerine uygun zarif bir üründür.**

With its strong and simple design, it is an elegant product that meets requirement at accessibility.





**Koltuk Tipi Merdiven Asansörü**, yaşlı ve engelliler için tasarlanmış, her türlü merdiven yapılarında çalışabilen sade ve mükemmel bir üründür. Kullanıcıların güvenli bir şekilde ulaşımını sağlamak amacı ile her türlü emniyet önlemi düşünülmüştür. Güçlü ve basit dizaynı sayesinde, erişilebilirliğin gerekliliklerine uygun zarif bir üründür.

Seat Type Stair Lift is a simple and perfect product designed for elderly and disabled people and can work in all kinds of staircase structures. All kinds of safety measures have been considered in order to ensure safe travel of the users. With its strong and simple design, it is an elegant product that meets the requirements of accessibility.

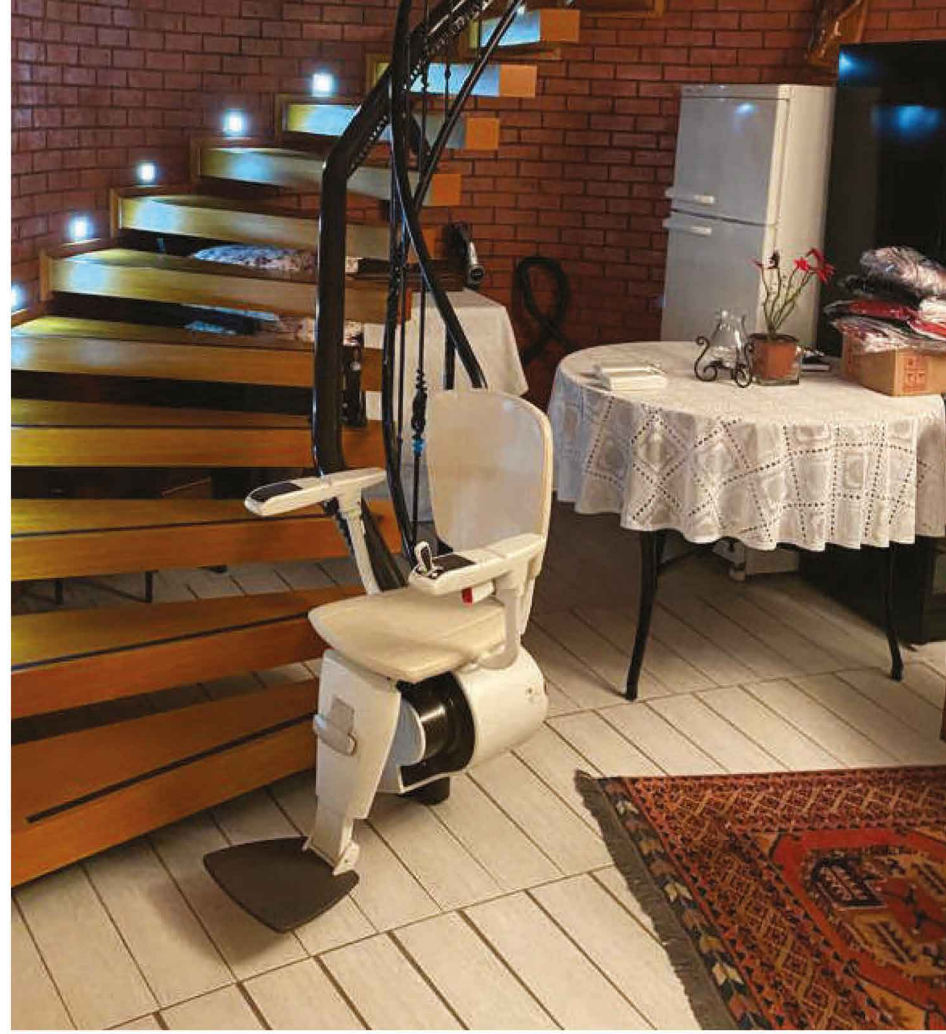

### TEKNİK ÖZELLİKLER | TECHNICAL SPECIFICATIONS

<b>Uygulama</b> Application	<b>Düz ve Dönüslü Merdivenler / İç-Dış Mekan</b> Straight and Swivel Stairs / Indoor-Outdoor
<b>Tahrik Tipi</b> Drive Type	<b>Dişli Sistemi</b> Gear System
<b>Taşıma Kapasitesi</b> Carrying Capacity	<b>130 - 150 kg</b> 130 - 150 kg
<b>Çalışma Hızı</b> Working Speed	<b>0,07 / 0,13 m/sn</b> 0,07 / 0,13 m/sec
<b>Ray Sistemi</b> Rail System	<b>Özel Alüminyum Kızak Sistemi</b> Special Aluminum Guide System
<b>Çıkabilecek Eğim</b> Escalation Angle	<b>45 Derece</b> 45 Degrees
<b>Çağırma Butonu</b> Call Button	<b>Uzaktan Kumanda</b> Remote Control
<b>Koltuk Tipi</b> Seat Type	<b>Katlanır ve Döner Koltuk</b> Folding And Swivel Seat
<b>Şarj Noktaları</b> Charging Points	<b>Duraklarda Otomatik Şarj</b> Auto Charging in Stops
<b>Güvenlik Sistemi</b> Safety System	<b>Emniyet Kemeri-Destek Kolları-Temas Swichleri</b> Seat Belt-Support Arms-Contact Swiches
<b>Ana Güç Gerekşinimi</b> Main Power Requirement	<b>220 V AC - 50Hz - Monofaze</b> 220 V AC - 50Hz - Single Phase

# CYK 50 ÇİFT PİSTONLU YÜK PLATFORMU DOUBLE PISTON CARGO PLATFORM LIFT

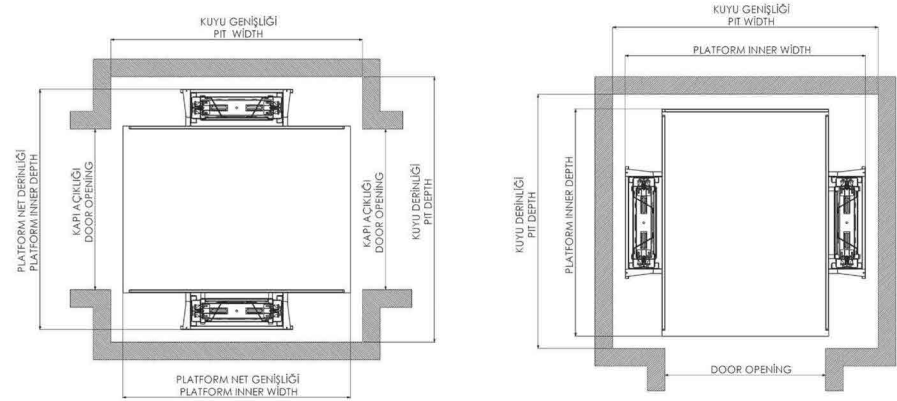
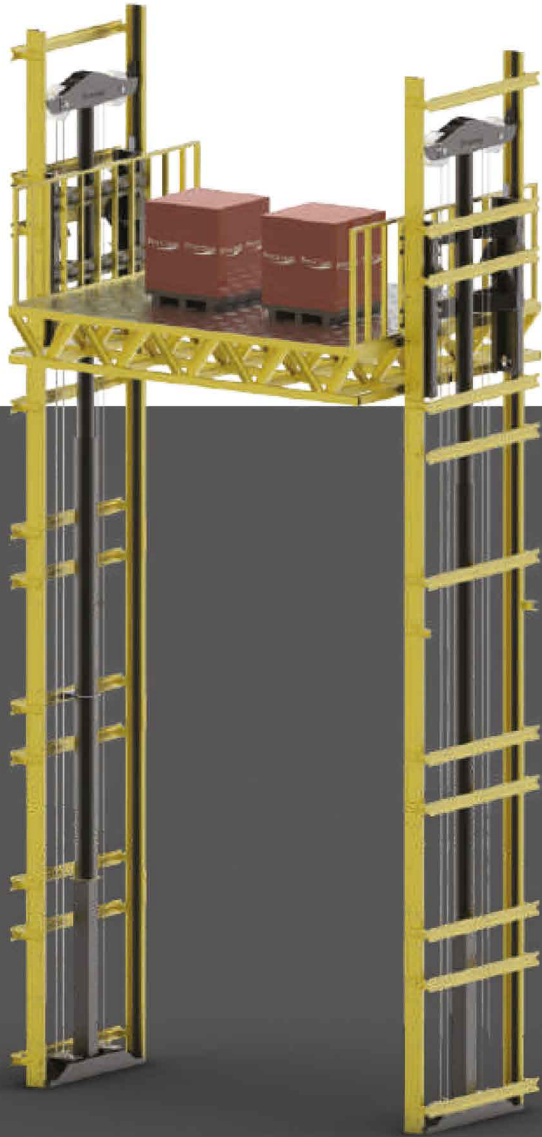

**20.000 Kilogram kapasitede ve 15 mt yükseklikte yapmak mümkündür.**

It is possible to make it with a capacity of 20.000 kilograms and a height of 15 meters.





Tablası büyük ve kaldırma kapasitesi yüksek yerlerde tercih edilir. 20.000 kg kadar, istenilen tabla ölçülerinde ve 15mt yüksekliğe kadar yapmak mümkündür. Karşılıklı çift ray ve çift piston kullanılır. Derin kuyu dibine ve son katta ek boşluklara ihtiyaç yoktur. Asansörler gibi ayrı bir makine dairesine ihtiyaç yoktur ve asansörlere göre daha ekonomiktir. Kurulum, çalıştırma ve bakım maliyetleri düşüktür. Yük ve çevre faktörleri için tüm gerekli güvenlik önlemleri alınmıştır. Kullanım alanları; araç asansörleri, depolar, alışveriş merkezleri, fabrikalar kısacası kat ve kot farkı olan yerlerde tercih edilir.

The platform is large and it is preferred in places with high lifting capacity. It is able to lift up to 20.000 kg load and able to lift from ground to 15 meter height. The platform dimensions will be specified according to customer needs. Reciprocating double rail and double piston are used. There is no need for a deep pit and additional spaces on the last floor. There is no need for a separate machine room like a passenger elevators and more economical than the elevators. Installation, commissioning and maintenance costs are low. All necessary safety precautions have been taken regarding the environment and freight. Area of usage; Car lifts, warehouses, shopping malls, factories and places with shorter floor and level difference etc.



### TEKNİK ÖZELLİKLER | TECHNICAL SPECIFICATIONS

<b>Tahrik Tipi</b> Drive Type	<b>Hidrolik</b> Hydraulic
<b>Taşıma Kapasitesi</b> Carrying Capacity	<b>500-20.000 kg</b> 500-20.000 kg
<b>Max. Seyir Mesafesi</b> Max. Travel Distance	<b>15.000 mm</b> 15.000 mm
<b>Çalışma Hızı</b> Working Speed	<b>0.15 m/sn</b> 0.15 m/sn
<b>Platform Dış Ölçüleri</b> Platform External Dimensions	<b>3300 x 2600 / ( Özel Ölçü )</b> 3300 x 2600 / ( Special Dimension )
<b>Platform İç Ölçüleri</b> Platform Internal Dimensions	<b>2500 x 2500 / ( Özel Ölçü )</b> 2500 x 2500 / ( Special Dimension )
<b>Kuyu Dibi</b> Pit	<b>Projeye göre</b> According to the project
<b>Çelik Konstrüksiyon</b> Steel Construction	<b>Projeye göre</b> According to the project
<b>Ana Güç Gerekşinimi</b> Main Power Requirement	<b>380 V AC - 50 Hz - Trifaze</b> 380 V AC - 50 Hz - Three Phase
<b>Acil Kurtarma</b> Emergency Rescue System	<b>Ups / Manuel</b> Ups / Manual

# TYK 15 TEK PİSTONLU YÜK PLATFORMU SINGLE PISTON CARGO PLATFORM LIFT

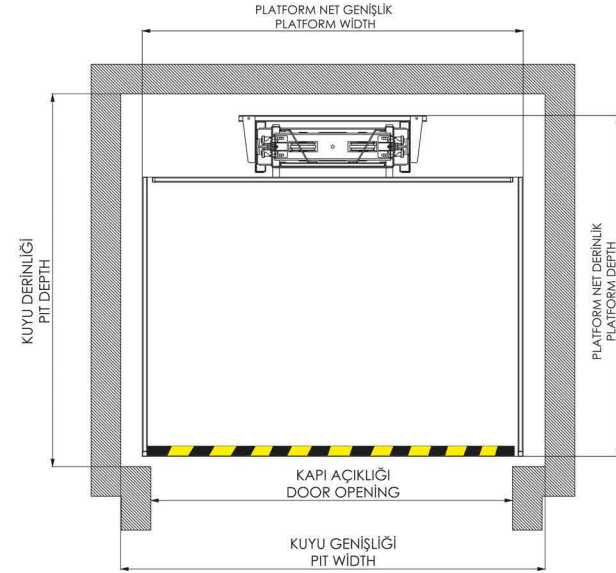

**3.000 Kilogram kapasitede ve 15 mt yükseklikte yapmak mümkündür.**

It is possible to make it with a capacity of 5.000 kilograms and a height of 15 meters.

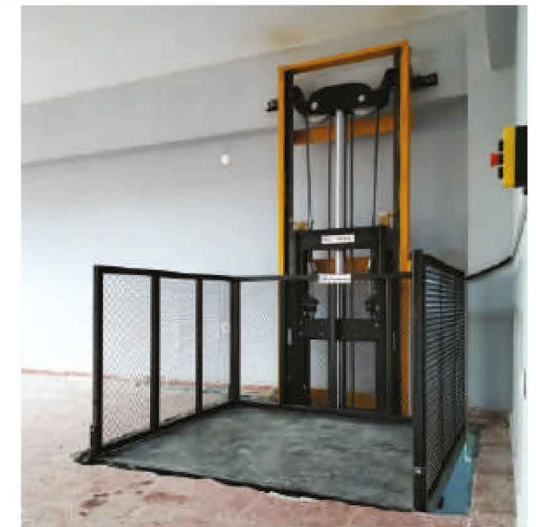
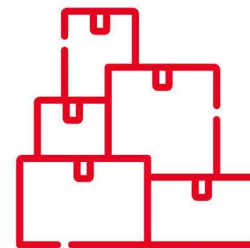



100 kg - 3000 kg taşıma kapasitesinde, istenilen tabla ölçülerinde ve 15mt yüksekliği kadar yapmak mümkündür. Platform üzerine ve etrafına korkuluk yapılabilir. Platformun 3 tarafından yükleme boşaltma yapılabilir. Derin kuyu dibine ve son kat yüksekliklerine ihtiyaç yoktur. Asansörler gibi ayrı bir makine dairesine gerek yoktur ve asansörlere göre daha ekonomiktir. Kurulum çalıştırma ve bakım maliyeti düşük platformlardır. Yük ve çevre faktörleri için tüm gerekli güvenlik önlemleri alınmıştır. Kullanım alanları; araç asansörleri, depolar, alışveriş merkezleri, fabrikalar kısacası kat ve kot farkı olan yerlerde tercih edilir.

It is able to lift from 100 kg to 3000 kg freights. Lifting distance is 15 meter height from floor. Platform dimensions will be specified according to customer needs. Optionally, safety rail will mount on and around the platform. 3 sides of the platform are suitable for unloading. There is no need for pit at bottom and top floor space. There is no need for a separate machine room like elevators. Moreover, it is economical than the elevators. Installation, commissioning and maintenance costs are low. All necessary safety precautions have been taken regarding the environmen and freight. Usage areas; car lifts, warehouses, shopping malls, factories and etc.

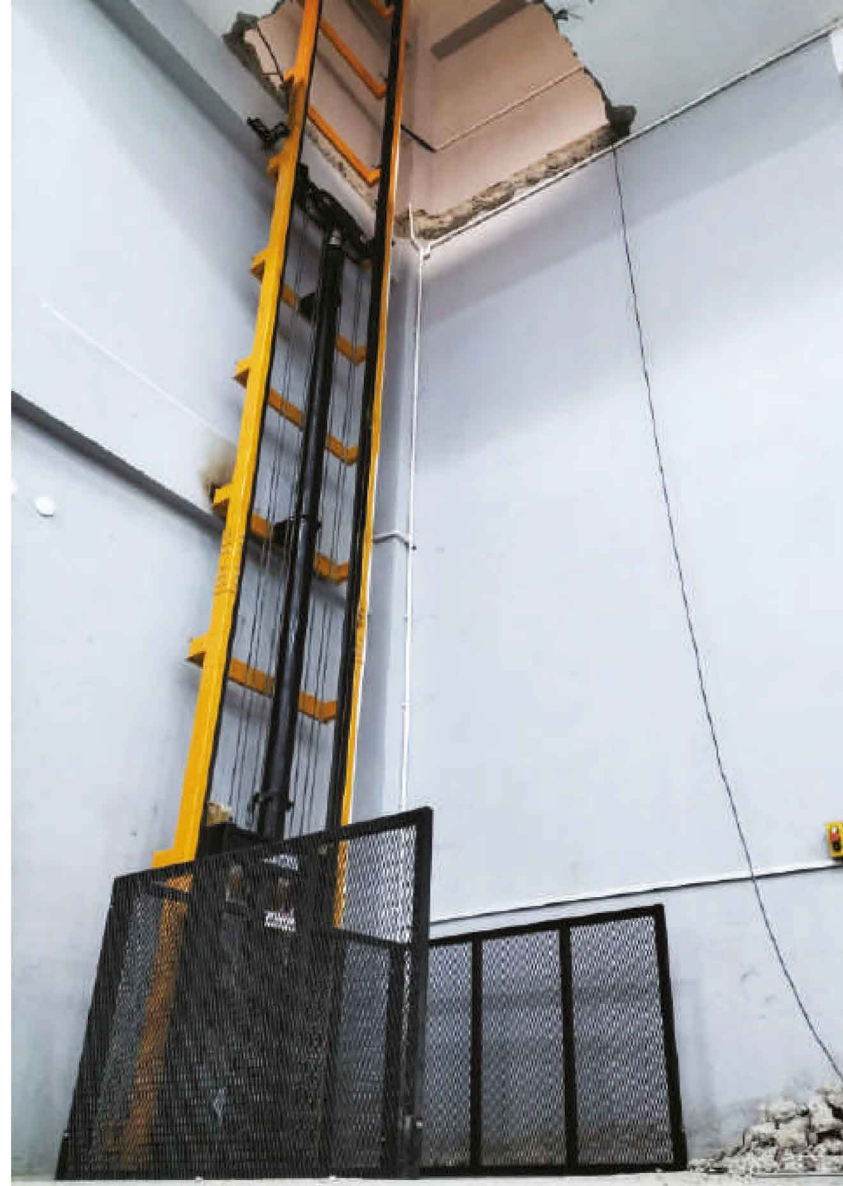

### TEKNİK ÖZELLİKLER | TECHNICAL SPECIFICATIONS

Tahrik Tipi Drive Type	Hidrolik Hydraulic
Taşıma Kapasitesi Carrying Capacity	100-3.000 kg 100-3.000 kg
Max. Seyir Mesafesi Max. Travel Distance	15.000 mm 15.000 mm
Çalışma Hızı Working Speed	0.15 m/sn 0.15 m/sn
Platform Dış Ölçüleri Platform External Dimensions	1600 x 1900 / ( Özel Ölçü ) 1600 x 1900 / ( Special Dimension )
Platform İç Ölçüleri Platform Internal Dimensions	1500 x 1500 / ( Özel Ölçü ) 1500 x 1500 / ( Special Dimension )
Kuyu Dibi Pit	Projeye göre According to the project
Çelik Konstrüksiyon Steel Construction	Projeye göre According to the project
Ana Güç Gereksinimi Main Power Requirement	380 V AC - 50 Hz - Trifaze 380 V AC - 50 Hz - Three Phase
Acil Kurtarma Emergency Rescue System	Ups / Manuel Ups / Manual



**OTO 62**

**ARAÇ PLATFORMU**  
PARKING PLATFORM LIFT



**Tek aracın park edeceği noktaya  
2 araç park etme imkanı sağlar**

It provides the opportunity to park 2 vehicles at the  
point where 1 vehicle is parked





Tek aracın park edeceği noktaya 2 araç park etme imkanı sağlar. Küçük otoparklar için otoparkınızı etkin ve verimli kullanmanıza imkan sağlar. Günümüzün getirdiği toprak maliyetlerini yarıya düşürmek için tasarlanmış güvenilir ve garantili ürünlerdir. Ziyaretçiler için alt kat yerler ve kalıcı kullanıcılar için üst kat otopark yerleri kullanılır. Aşınmaya dayanımlı hareketli mafsallar, ve kanıtlanmış hidrolik teknolojisi ile düşük bakım ve maliyet getirir.

Bizce garajlarınız yaşam alanına dönüştüğünde daha değerli olurdu. Bu doğrultuda ilerleyerek, daha güvenli ve daha verimli olan oto 62 araç asansörleri üretildi.

Aracınızı dış etkenlerden tamamen izole edin, Aracınız için maksimum güvenlik sağlayın, Bahçenizde daha dekoratif alanlar yaratın, Tek araçlık park alanınıza iki araç park edin. Türkiye'de bu ayrıcalığı yaşayan ilklerden biride siz olun.

It allows you to use your car parking efficiently. It is Designed to minimize the space required for parking.

Downstairs places for visitors and upstairs parking spaces for permanent users low maintenance and cost. Wear-resistant mobile joints, and proven hydraulic technology.

When our parking will turned into living spaces. It would more valuable to us.

For the moving in this direction, more reliable and more efficient vehicle lifts were produced. Isolate your vehicle from external influences, maximum provide security for your vehicle. Create more spaces in your garden. Be the first to get one parking for two vehicles by this privilege.



## TEKNİK ÖZELLİKLER | TECHNICAL SPECIFICATIONS

<b>Tahrik Tipi</b> Drive System	Hidrolik Hydraulic
<b>Taşıma Kapasitesi</b> Carrying Capacity	2500 - 10000 kg 2500 - 10000 kg
<b>Max Seyir Mesafesi</b> Max. Travel Distance	15.000 mm 15.000 mm
<b>Çalışma Hızı</b> Working Speed	0.15 m/sn 0.15 m/sn
<b>Platform İç Ölçüleri</b> Platform Internal Dimensions	2800 x 5000 mm / ( Özel Ölçü ) 2800 x 5000 mm / ( Special Dimensions )
<b>Platform Dış Ölçüleri</b> Platform External Dimensions	3600 x 5100 mm / ( Özel Ölçü ) 3600 x 5100 mm / ( Special Dimensions )
<b>Kuyu Dibi</b> Pit	Projeye göre According to the Project
<b>Acil Kurtarma Sistemi</b> Emergency Rescue System	Ups / Manuel Ups / Manual
<b>Ana Güç Gerekşinimi</b> Main Power Requirement	380 V AC - 50 HZ - Trifaze 380 V AC - 50 HZ - Three Phase



**YMK-80**

**YEMEK PLATFORMU**  
FOOD PLATFORM LIFT

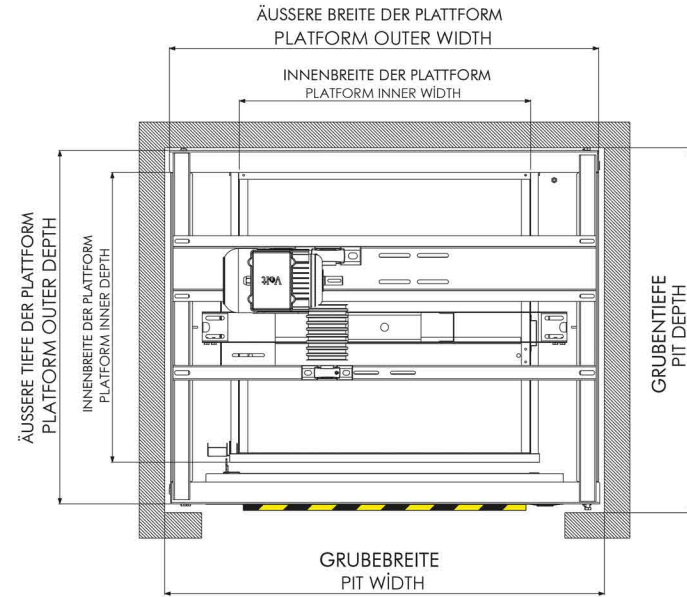

**Yemeklerinizi soğumadan hızlıca  
göndermenin en kısa yolu**

The quickest way to send your meal without it going cold

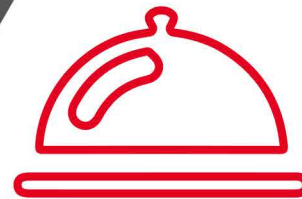



Monşarj asansörler, uluslararası standartlarca belirlenen ve kullanım amacı daha çok tepsi, tepsi arabası, tabak, bardak vs. taşımak olan, boyutları ve şekli küçük yüklerin taşınması için tasarlanmış, insanların giremeyeceği bir kabini olan asansörlerdir. 50 kg'dan 300 kg'a kadar farklı taşıma kapasitelerine sahiptirler. Genelde giyotin tipte kapı kullanılır.

#### Uygulama Alanları

Hastaneler, restoranlar, alışveriş merkezlerinde; yemek, dosya, alışveriş sepeti, çamaşır arabası gibi yükleri taşımak için kullanılır.

Dumbwaiters are mostly used for trays, tray trolleys, plates, glasses, and other items that must adhere to international standards. They are elevators with a cabin that no one can enter and are designed to transport small loads of varying size and shape. They have carrying capacities ranging from 50 kg to 300 kg. In most cases, guillotine doors are used.

#### Application range

It is used to transport loads such as food, files, shopping baskets, and laundry trolleys in hospitals, restaurants, and shopping centers.

Ürünlerimiz TS EN 81-41 ve 2006/42/EC Makine Emniyet Direktiflerine uygun CE Sertifikalıdır.

Our products comply with the Machine Safety Directions TS EN 81-41 ve 2006/42/EC and has CE certificate



#### TEKNİK ÖZELLİKLER | TECHNICAL SPECIFICATIONS

Ürün Bilgileri Product Information	Monşarj Teknik Özellikleri (Tr) Dumbwaiter technical specification (En)
Durak Sayısı Number Of Stop	Min. 2 Dr. (Diagonal) Maks. 13 Dr. (Diagonal) Min. 2 stops (Diagonal) Max. 13 stops (Diagonal)
Kuyu Boyu Mesafesi Pit Depth	Minimum 1200 mm Maksimum 46000 mm Minimum 1200 mm Maximum 46000 mm
Hız Speed	Minimum 0,07 Mt/Sn Maksimum 0,40 Mt/Sn Minimum 0,07 Mt/Sn Maximum 0,40 Mt/Sn
Taşıma Kapasitesi Carrying Capacity	Minimum 150 Kg Maksimum 250 Kg Minimum 150 Kg Maximum 250 Kg
Kabin İç Ölçüsü Cabin Inner Size	Minimum 300x300 mm Maksimum 1200x1200 mm Minimum 300x300 mm Maximum 1200x1200 mm
Platform Dış Ölçüsü Platform Outer Size	Minimum 650x550 mm Maksimum 1550x1450 mm Minimum 650x550 mm Maximum 1550x1450 mm
Kabin Özelliği Cabin Feature	304 Kalite Satine Paslanmaz 304 quality stainless steel
Kabin Zemin Kaplaması Platform Floor Covering	Paslanmaz Stainless Steel
Motor Motor	Minimum Bonfiglioli (0,75 Kw - 380 Volt) Maksimum Bonfiglioli (1,50 Kw - 380 Volt) Minimum Bonfiglioli (0,75 Kw - 380 Volt) Maximum Bonfiglioli (1,50 Kw - 380 Volt)
Kumanda Panosu Control Panel	Arkel ARL 100 Arkel ARL 100
Tahrik Sistemi Drive System	Tamburlu Karşı Ağırlıklı Yan Ağırlıklı Hoist Drum Counter Weighted Side Weighted

#### TEKNİK ÖZELLİKLER | TECHNICAL SPECIFICATIONS

Kat Çağrı Butonları Floor Call Buttons	Buton Buton
Çelik Konstrüksiyon Steel Structure	Var Yok Yes No
Çelik Konstrüksiyon Kaplaması Steel Structure Coating	Galvaniz Galvanized
Kuyu Kaplama Malzemesi Well Coating Material	Yok No
Ana Güç Gerekirimi Main Power Requirement	380 Volt AC, 50 Hz, Trifaze 380 Volt AC, 50 Hz, 3 Phase
Kat Kapısı Floor Door	Minimum 300x300 mm Giyotin Paslanmaz / Manuel Maksimum 1200x1200 mm Giyotin Paslanmaz / Manuel / Minimum 300x300 mm Giyotin Stainless Steel / Manual Maximum 1200x1200 mm Giyotin Stainless Steel / Manual
Ray Rail	50x50x5 50x50x5
Halat Steel Rope	6.5 mm Çelik 6.5 mm Steel



**PUMALIFT**  
Asansör

**Address:**

**Fevzi Çakmak Mh.**

**Medcezir Cad. No: 35/F**

**Karatay / Konya**

**İletişim**

**+90 533 619 53 42**

**+90 332 248 18 18**

**E-posta**

**export@pumaliftasansor.com**



**www.pumaliftasansor.com**

*Engelleri  
Kaldıran  
Teknoloji*